



# Katalog produktów

01 / 2021



Już wkrótce kolejne nowości.



## **Elitarna grupa Produktów polecana przez Profesjonalistów**

Kominki KRATKI PRO są odpowiedzią na potrzeby wszystkich Klientów, którzy szukają urządzeń najwyższej jakości, bezpiecznych, ekonomicznych i ekologicznych. Kratki PRO to pewność, że produkty zostały zaprojektowane oraz wykonane z użyciem najnowocześniejszych rozwiązań technologicznych.

Wszystkie projekty, które tworzymy powstają z myślą o potrzebach naszych Klientów. Funkcjonalność, wysoka jakość oraz niewygórowana cena - to cechy, które wyróżniają nasze wkłady na rynku. Dbalność o estetykę i stylistykę pozwala ich użytkownikom na dowolność aranżacji. Jedyną barierą staje się własna wyobraźnia, ale - jak dowodzi nasze wieloletnie doświadczenie - Klienci mają jej nieograniczone pokłady.

Dajemy ciepło - to najważniejsze zadanie naszych wkładów. Siedząc w blasku kominka zrozumieją Państwo, że robimy jednak coś więcej...  
**Tworzymy atmosferę, ciepłą atmosferę...**

*Marek Biał*



A modern living room with a fireplace, two sofas, and a rug. The fireplace is the central focus, with a fire burning inside. The room has a warm, cozy atmosphere. The walls are a light, textured color, and the floor is made of wood. There are two blue sofas on either side of the fireplace, and a stack of books on the floor next to each. A blue patterned rug is on the floor in front of the fireplace.

Dajemy ciepło,  
aby powroty do domu  
były jeszcze miłsze

„We provide warmth...“ / „Wir geben Wärme“ / „Мы даём тепло...“ / „Dáváme teplo...“ / „Nous donnons la chaleur...“ /  
„Προσφέρουμε ζεστασιά ...“ / „Offriamo il calore...“ / „Damos calidez...“

All of the projects created by us meet the needs of our customers. Functionality, high quality and reasonable price are the features that distinguish our inserts on the market. Attention to aesthetics and style enable their users to arbitrarily arrange interiors. Imagination is the only barrier, but - as evidenced by our many years of experience - customers have unlimited resources of it.

We provide warmth - this is the most important task of our inserts.  
Sitting in the glow of a fireplace, you can realize that we do much more...  
We create a special warm, welcoming atmosphere...

Alle Projekte, die wir erstellen, entstehen mit dem Gedanken an Bedürfnisse unserer Kunden. Funktionalität, hohe Qualität und kein hoher Preis - sind Merkmale, die unsere Einsätze auf dem Markt bevorzugen. Ästhetik und Stil der Einsätze erlauben den Benutzern beliebige Einrichtung. Zu einzigem Hindernis wird eigene Vorstellung, aber - wie unsere vieljährige Erfahrung beweist - haben die Kunden unbeschränkte Vorstellungen.

Wir geben Wärme - es ist die wichtigste Aufgabe unserer Einsätze.  
Indem Sie vor dem Kaminglanz sitzen, werden Sie verstehen, dass wir doch mehr machen...  
Wir schaffen Atmosphäre, warme Atmosphäre...

Все проекты мы создаём с мыслью об удовлетворении потребностей наших клиентов. Функциональность, высокое качество и разумные цены - вот те особенности, которые отличают нашу продукцию на рынке. Внимание к эстетике и стилю даёт пользователям свободу выбора для возможности комбинировать. Единственным барьером становится собственное воображение, но - как свидетельствует наш многолетний опыт - Клиенты имеют его в неограниченных запасах.

Мы даём тепло - это самая важная задача наших усилий.  
Сидя в лучах камина, вы поймёте, что мы делаем нечто большее...  
Мы создаём атмосферу, атмосферу тепла...

Všechny projekty, které tvoříme, vznikají se snahou splnit potřeby našich zákazníků. Funkčnost, vysoká kvalita a rozumná cena - jsou vlastnosti, kterými se naše výrobky odlišují na trhu. Péče o estetiku a stylistiku umožňuje jejich uživatelům libovolnou aranžaci. Jedinou bariérou se stává vlastní představitelství, ale - jak dokazují naše mnohaleté zkušenosti - zákazníci mají neomezené představy.

Dáváme teplo - je to nejdůležitější úkol našich vložek.  
Když ale budete sedět u záře krbu, pochopíte, že děláme ještě něco navíc...  
Tvoříme atmosféru, teplou atmosféru...

Tous nos projets sont créés pour répondre aux besoins de nos clients. La fonctionnalité, la haute qualité et le prix raisonnable - ce sont les caractéristiques qui distinguent nos cheminées sur le marché. Le souci de l'esthétique et du style permet à leurs utilisateurs de réaliser de différents arrangements. Le seul obstacle devient l'imagination, mais - comme en témoignent nos nombreuses années d'expérience - les clients ont des ressources illimitées.

Nous donnons la chaleur - ce qui est la tâche la plus importante de nos produits.  
Assis dans la lueur de la cheminée, vous comprendrez que nous faisons quelque chose de plus...  
Nous créons une atmosphère, un accueil chaleureux...

Όλες οι εκτελέσεις μας, δημιουργούνται με τρόπο και με βάση τις ανάγκες των πελατών μας. Η λειτουργικότητα, η υψηλή ποιότητα και οι λογικές τιμές που προσφέρουμε, αποτελούν μερικά από τα χαρακτηριστικά που κάνουν τα τζάκια μας να ξεχωρίζουν στην αγορά. Η αισθητική και το ύφος που έχουν δοθεί στα προϊόντα μας, προσφέρουν στους χρήστες μια ευρεία επιλογή διακόσμησης. Μοναδικό εμπόδιο μπορεί να αποτελέσει η προσωπική φαντασία, αλλά όπως αποδεικνύεται μέσα από τα πολλά χρόνια εμπειρίας μας, οι πελάτες μας διαθέτουν φαντασία σε απεριόριστα επίπεδα.

Προσφέρουμε ζεστασιά - αφού η σημαντικότερη αποστολή των τζακιών της εταιρείας μας.  
Βλέποντας την λάμψη που πηγάζει από το εσωτερικό των τζακιών μας, μπορείτε να καταλάβετε ότι έχουμε δημιουργήσει κάτι διαφορετικό...  
Έχουμε δημιουργήσει μια ατμόσφαιρα, μια ζεστή ατμόσφαιρα...

Stiamo creando tutti i progetti pensando alle esigenze dei nostri Clienti. La funzionalità, l'alta qualità e il prezzo non eccessivo sono le caratteristiche che distinguono i nostri inserti sul mercato. La cura dell'estetica e stile permette ai loro utenti un arraggiamento preferibile. L'unica barriera è la propria immaginazione, ma - come dimostra l'esperienza di tanti anni - i Clienti ne hanno illimitata.

Offriamo il calore - è un principale compito dei nostri inserti.  
Seduti nello splendore del caminetto capirete che abbiamo fatto qualcosa in più...  
Creiamo un'atmosfera, un'atmosfera calda...

Todos los proyectos que creamos lo hacemos pensando en las necesidades de nuestros clientes. La funcionalidad, la alta calidad y un precio asequible son las características que nos distinguen en el mercado. La estética y el estilo de nuestros hogares permiten decorar una estancia acorde a las preferencias de nuestros usuarios. Gracias a nuestra experiencia, la imaginación y las necesidades de nuestros clientes no son un obstáculo.

Dar calidez es la tarea más importante para nuestros hogares.  
Cuando se siente frente al fuego, entenderá que hemos hecho mucho más. Creamos un ambiente, un ambiente cálido...



Siedząc w blasku kominka  
zrozumieją Państwo,  
że robimy jednak coś więcej...

„Sitting in the glow of a fireplace, you can realize that we do much more...”

„Indem Sie vor dem Kaminglanz sitzen, werden Sie verstehen, dass wir doch mehr machen...”

„Сидя в лучах камина, вы поймёте, что мы делаем нечто большее...”

„Když ale budete sedět u záře krbu, pochopíte, že děláme ještě něco navíc...”

„Assis dans la lueur de la cheminée, vous comprendrez que nous faisons quelque chose de plus...”

„Βλέποντας την λάμψη που πηγάζει από το εσωτερικό των τζακιών μας, μπορείτε να καταλάβετε ότι έχουμε δημιουργήσει κάτι διαφορετικό...”

„Seduti nello splendore del caminetto capirete che abbiamo fatto qualcosa in più...”

„Cuando se siente frente al fuego, entenderá que hemos hecho mucho más...”

Dodatkowe opcje/Oznaczenia stosowane w katalogu Additional options/Symbols used in catalogue Zusätzliche Optionen/Die Bezeichnungen im Katalog Дополнительные опции/Символы, используемые в этом каталоге.....	18 - 21
Wyposażenie wkładów powietrznych Advantages of traditional fireplace inserts Die Vorteile der traditionellen Kamineinsätze Преимущества традиционных топок.....	21 - 23
Wkłady powietrzne Traditional fireplace inserts Traditionelle Kamineinsätze Традиционные топки.....	24 - 89
Wkłady stalowe Steel inserts Stählere Kamineinsätze Топки стальные.....	24 - 63
Wkłady żeliwne Cast iron inserts Gusseiserne Kamineinsätze Топки чугунные.....	64 - 87
Wyposażenie wkładów wodnych Advantages of water inserts Vorteile der wasserführenden Kamineinsätze Преимущества топок с водяным контуром.....	92 - 95
Wkłady wodne Inserts with water jacket Wasserführende Kamineinsätze Топки с водяным контуром.....	96 - 121
KOZA AB S GAZ / LEO / PATIO / UMBRELLA .....	122-137
Palenisko gazowe AQF / Gas furnace AQF / Gasofen AQF / газовая печь AQF.....	138-139
Pieczyki w obudowie z kafli / Ceramic surrounded stoves / Kachelöfen / Печи в кафельной обли.....	144 - 145
Wyposażenie pieców wolnostojących Advantages for freestanding stoves Vorteile der freistehenden Öfen Преимущества печи.....	146 - 147
Piece wolnostojące Freestanding stoves Freistehende Kaminöfen Печи.....	148 - 177
VIKING.....	178-179
Zalety kratki kominkowych Advantages of fireplace grids Vorteile der Lüftungsgitter Преимущества каминных решеток.....	182 - 183
Kratki kominkowe / Fireplace grids / Lüftungsgitter/ Решётки для каминов.....	184 - 189
Sterowniki / Controllers / Steuerer / Контроллеры.....	190 - 191
Nasady kominkowe Chimney heads Kamin abgaswärmetauscher Дымоходные теплообменники.....	194 - 195

Dodatečné vybavení/Označení používaná v katalogu Options supplémentaires/Description des symboles Επιπλέον επιλογές/Σύμβολα, που χρησιμοποιηθήκαν στον κατάλογο Opzioni aggiuntive/Simboli usati nel catalogo Opciones adicionales/Símbolos usados en el catálogo.....	18- 21
Přednosti teplovzdušných krbových vložek Avantages des foyers fermés à bois (traditionnels) Πλεονεκτήματα των εστιών αέρα Vantaggi contributi dell'aria Las ventajas de los hogares tradicionales.....	22 - 23
Teplovzdušné krbové vložky Foyers fermés à bois (traditionnels) Εστιές αέρα Contributi dell'aria Hogares tradicionales.....	24 - 89
Litinové vložky / Foyers à bois en fonte / Εστιές από μαντέμι / Contributi con ghisa / Hogares de fundición.....	24 - 63
Ocelové vložky / Foyers à bois en acier / Εστιές από χάλυβα / Contributi acciaio / Hogares de acero.....	64 - 87
Přednosti teplovodních krbových vložek Avantages des foyers chaudières à bois avec production d'eau chaude Πλεονεκτήματα των εστιών καλοριφέρ Vantaggi contributi dell'acqua Ventajas de los hogares calefactores.....	92 - 95
Teplovodní krbové vložky / Foyers chaudières à bois avec production d'eau chaude / Εστιές καλοριφέρ / Contributi dell'acqua / Hogares con intercambiador de agua.....	96 - 121
KOZA AB S GAZ / LEO / PATIO / UMBRELLA.....	122-137
Plynová pec AQF / Fournaise à gaz AQF / Φούρνος αερίου AQF / Forno a gas AQF / Horno de gas AQF.....	138-139
Kachlová kamna Foyer à bois avec habillage en faïence Τζακόσομπες με επένδυση κεραμικού συσσώρευσης Stufe in maiolica Estufas con revestimiento cerámico.....	144 - 145
Volně stojící kamna / Poêles à bois / Ενεργειακές τζακόσομπες / Stuffa per legno / Estufas.....	148 - 177
VIKING.....	178-179
Přednosti krbových mřížek Les avantages de grilles d'aération Πλεονεκτήματα περσιδών Vantaggi griglie per camino Ventajas de los difusores.....	182 - 183
Krbové mřížky / Grilles d'aération / Περσιδες τζακιών / Griglia per caminetti / Difusores para chimeneas.....	184 - 189
Regulace / Contrôleurs / Τύπος του ηλεκτρονικού συστήματος ελέγχου / Controlli / Controladores.....	190 - 191
Krbové nástavce / Tête d'insert Échangeur Air/Eau / Εναλλακτες καπναεριων / Teste di camino / Intercambiadores de calor.....	194 - 195

Skutečné barvy výrobků uvedených na fotografiích se mohou mírně lišit od odstínů a barev, uvedených v katalogu, zobrazená barevná provedení by měla být považována za orientační. Les couleurs des produits sur les photos peuvent légèrement diverger des couleurs réelles. Photos à titre indicatif seulement.

Οι αποχρώσεις των προϊόντων στον κατάλογο μπορεί να παρουσιάζουν μικρή απόκλιση από την πραγματικότητα.

Colori i prodotti visibilità in foto può poco discostarsi del reale tonalità e colori ha quindi presentato i colori dovrebbero essere da ritenersi indicativi.

Los colores de los productos mostrados en las fotos pueden variar dependiendo de la impresión, motivo por el cual deben ser tratados como orientativos.



## Partner technologiczny

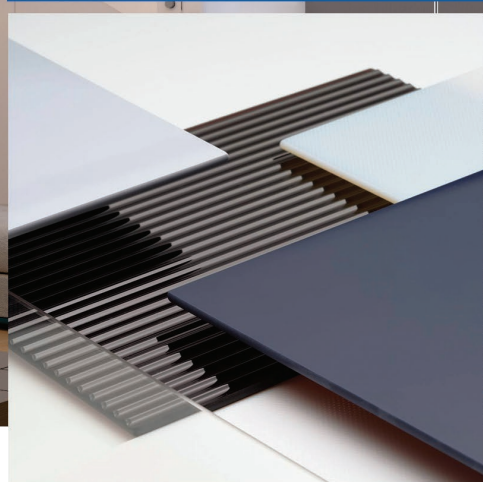

SCHOTT jest wiodącą międzynarodową grupą technologiczną w dziedzinie szkła specjalistycznego i ceramiki szklanej. Dzięki ponad 130-letniemu doświadczeniu w zakresie rozwoju, materiałów i technologii oferujemy szeroką paletę wysokiej jakości produktów i inteligentnych rozwiązań, które przyczyniają się do sukcesu naszych klientów.

Nasza pasja do szkła jest rozbudzona przez wyobraźnię i podsycona fachową wiedzą. Cokolwiek Państwo sobie wyobrazicie, znajdziemy sposób, aby to zrealizować. Odkrywamy na nowo szkło we wszystkich jego licznych właściwościach. Możemy je zginać, związać, łączyć z metalem, podpalać, zaokrąglać, zamieniać w proszek szklany lub robić je ultra cienkie. SCHOTT tworzy rozwiązania, które wprowadzają w życie unikalne produkty i nowe zastosowania.

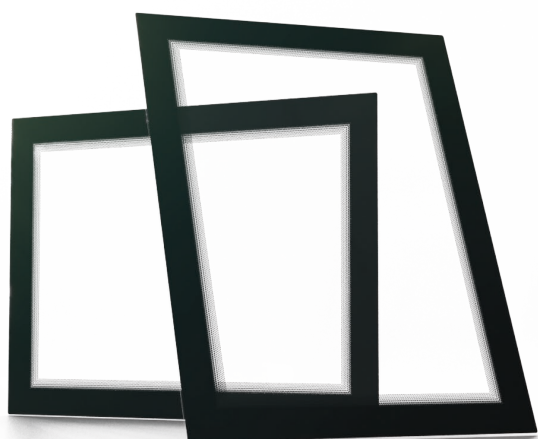

## The World of SCHOTT

Znajdź nas na:



# O Firmie

About company / Über uns / O компании / O nás / A propos de nous  
/ Σχετικά με εμάς / Chi siamo / Sobre nosotros

Nasza firma istnieje na rynku polskim od 1998 roku, kiedy to rozpoczęliśmy produkcję kratki kominkowych. Dziś jesteśmy znanymi i cenionymi producentem kominków, kratki oraz akcesoriów kominkowych. Dzięki dynamicznemu rozwojowi, wysokiej jakości i trwałości naszych produktów, szybko znaleźliśmy się w czołówce firm kominkowych w Europie.

Our company has been existing on the Polish market since 1998, when we started to produce fireplace grates. Today, we are a well-known and respected manufacturer of fireplaces, grills and fireplace accessories. Due to our dynamic development, quality and durability of our products, we are known at the forefront of fireplace manufacturers in Europe.

Unsere Firma gibt es auf dem polnischen Markt seit 1998. In diesem Jahr haben wir mit der Produktion von Kamingittern begonnen. Heute sind wir ein bekannter und begehrter Hersteller von Kaminen, Kamingittern und Kaminzubehör. Dank dynamischer Entwicklung, hoher Qualität und großer Lebensdauer unserer Produkte befinden wir uns an der Spitze der Kaminfirmen in Europa.

Наша компания существует на польском рынке с 1998 года, в то время мы начали производство каминных решёток. Сегодня мы являемся известными и уважаемыми производителями каминов, грилей и каминных аксессуаров. Благодаря динамичному развитию, качеству и долговечности нашей продукции, мы скоро оказались в авангарде фирм по производству каминов в Европе.

Naše firma existuje na polském trhu od roku 1998, kdy jsme zahájili výrobu krbových mříží. Dnes jsme známým a vysoce hodnoceným výrobcem krbů, mříží a příslušenství pro krby. Díky dynamickému rozvoji, vysoké kvalitě a trvanlivosti našich výrobků, rychle jsme se stali jednou z nejlepších firem přes krby v Evropě.

Notre société existe sur le marché polonais depuis 1998, quand nous avons commencé la production de grilles de foyer. Aujourd'hui, nous sommes un fabricant reconnu de cheminées, grilles et accessoires de cheminée. Grâce au développement dynamique, à la qualité et la durabilité de nos produits, nous nous sommes rapidement trouvés parmi les leaders de cheminées en Europe.

Η εταιρεία μας δραστηριοποιείται στην πολωνική αγορά από το 1998, όταν και ξεκίνησε να κατασκευάζει περιόδους τζακιών. Αυτή τη στιγμή είμαστε μια ευρέως γνωστή και αναγνωρισμένη κατασκευαστική εταιρεία τζακιών και αξεσουάρ τζακιού. Χάρη στην δυναμική ανάπτυξη, την υψηλή ποιότητα και την ανθεκτικότητα των προϊόντων μας, βρεθήκαμε γρήγορα στην πρώτη γραμμή ανάμεσα στις κατασκευαστικές εταιρείες τζακιών της Ευρώπης.

La nostra ditta esiste sul mercato dal 1998, quando abbiamo incominciato a produrre le griglie per caminetti. Oggi siamo un produttore conosciuto ed apprezzato di caminetti, griglie e accessori per caminetti. Grazie a un dinamico sviluppo, alta qualità e durevolezza dei nostri prodotti, in breve tempo ci siamo posizionati fra i più principali ditte di caminetti in Europa.

Nuestra compañía está presente en el mercado polaco desde 1998, cuando nos iniciábamos en la producción de difusores para chimeneas. A día de hoy somos un reconocido y popular fabricante de chimeneas, difusores y accesorios para chimeneas. Gracias al desarrollo dinámico, la alta calidad y la durabilidad de nuestros productos, somos líderes en la fabricación de chimeneas en Europa.





System  
zarządzania  
ISO 9001:2015

www.tuv.com  
ID 019810012990



Od początku istnienia przyświeca nam idea „Dobre, bo polskie”, a wyróżnikiem na tle konkurencji jest troska o dostarczenie Klientom produktu bezpiecznego i efektywnego. Dbamy, by nasze urządzenia spełniały najwyższe standardy i były zgodne z restrykcyjnymi normami. Niezawodną jakość oferowanych usług zapewnia doświadczona kadra sprzedażowa, posiadająca szeroką wiedzę techniczną na temat produktów, instalacji i logistyki.

Since our company's inception, we are guided by the idea of products being „Good because they are Polish” and we are different from the competition due to our concern to provide customers with safe and effective products. We make sure that our products meet the highest standards and comply with the most stringent standards. Our experienced sales staff provide reliable quality of services, they have wide technical knowledge of products, installation and logistics.

Vom Anfang an richten wir uns nach der Idee „Gut, da in Polen hergestellt”, und das Merkmal, welches uns von der Konkurrenz unterscheidet, ist die Sorge, um den Kunden ein sicheres und wirkungsvolles Produkt zu liefern. Wir kümmern uns, damit unsere Produkte den höchsten Standards entsprechen und strenge Normen erfüllen. Unser erfahrenes Verkaufsteam mit großen technischen Kenntnissen im Bereich der Produkte, Installation und Logistik gewährleistet zuverlässige Qualität der angebotenen Dienstleistungen.

С момента создания, нами двигает идея «Хорошее, потому что польское», нашей отличительной от конкурентов чертой является забота о предоставлении клиентам безопасных и эффективных продуктов. Мы заботимся о том, чтоб наше оборудование отвечало самым высоким стандартам и соответствовало ограничительным нормам. Надёжное качество предлагаемых услуг обеспечивают опытные менеджеры по продажам, имеющие широкие технические знания о продукции, монтаже и логистике.

Od začátku naší existence nás provází motto „Dobré, protože polské” a od konkurence nás odlišuje péče o to, abychom dodávali zákazníkům bezpečné a výkonné výrobky. Snažíme se o to, aby naše zařízení splňovaly nejvyšší standardy a byly v souladu s přísnými normami. Spolehlivou kvalitu námi nabízených služeb zajišťuje zkušený personál v oblasti prodeje, který má široké technické znalosti ohledně výrobků, instalací a logistiky.

Depuis notre création, nous sommes guidés par l'idée „Bon car polonais” et notre différenciation de la concurrence est le souci de fournir aux clients des produits sûrs et efficaces. Nous prenons soin que nos produits répondent aux normes les plus élevées et soient conformes à des normes strictes. La qualité fiable de nos services est assurée par un personnel expérimenté qui possède de vastes connaissances techniques sur les produits, l'installation et la logistique.

Από την πρώτη μέρα ύπαρξής μας, μας οδηγούσε μια ιδέα που έλεγε «καλό, γιατί είναι Πολωνικό», ενώ αυτό που μας έκανε να διαφέρουμε από τους ανταγωνιστές μας, ήταν η παροχή στους πελάτες με προϊόντα ασφαλή και αποδοτικά. Φροντίζουμε ώστε οι συσκευές μας να πληρούν τα υψηλότερα πρότυπα και να συμμορφώνονται με τις πιο αυστηρές προδιαγραφές. Η αξιόπιστη ποιότητα των παρεχόμενων υπηρεσιών, εξασφαλίζεται από ένα έμπειρο προσωπικό πώλησης, το οποίο κατέχει ευρεία τεχνική γνώση σχετικά με τα προϊόντα, την εγκατάσταση και τον εφοδιασμό.

Dall'inizio seguiamo un'idea „Buono perché è polacco”; quello che ci distingue sul mercato è la cura nella consegna dei prodotti sicuri e efficaci ai Clienti. Ci impegniamo che i nostri impianti soddisfano i più alti standard e siano conformi con le norme restrittive. La qualità affidabile dei nostri servizi consente lo staff di vendita esperto, avente le ampie conoscenze tecniche sui prodotti, installazione e logistica.

С момента создания, нами двигает идея «Хорошее, потому что польское», нашей отличительной от конкурентов чертой является забота о предоставлении клиентам безопасных и эффективных продуктов. Мы заботимся о том, чтоб наше оборудование отвечало самым высоким стандартам и соответствовало ограничительным нормам. Надёжное качество предлагаемых услуг обеспечивают опытные менеджеры по продажам, имеющие широкие технические знания о продукции, монтаже и логистике.



Ogrzewać serca,  
ocieplać wnętrza,  
rozpalać wyobraźnię  
- wierzymy w naszą misję

Our mission is to: warm hearts, warm interiors, fire the imagination...

Unser Auftrag heißt: Herzen und Räume erwärmen, Gemüter erhitzen...

Наша миссия заключается в том, чтобы согревать сердца, утеплять интерьер, разжигать воображение...

Naší misí je: Rozehřívát srdce, zateplovat interiéry, rozpalovat představivost...

Notre mission: Chauffer les cœurs, chauffer les intérieurs, enflammer l'imagination...

Η αποστολή μας είναι: Να θερμαίνουμε τις καρδιές σας, να ζεσταίνουμε το εσωτερικό και να εξάπτουμε την φαντασία...

La nostra missione è: Riscaldare i cuori, riscaldare interni, accendere l'immaginazione...

Corazones y espacios cálidos, el fuego, la imaginación...



# Nasze cele:

Our objectives are: / Unser Ziel ist: / Наши цели это: / Našimi cíli jsou:



- tworzenie ciepłej atmosfery oraz dostarczenie ciepła domowego ogniska do domów naszych Klientów

- creating warm atmosphere and providing the warmth of hearth and home to the homes of our customers

- warme Atmosphäre zu schaffen und die Wärme des häuslichen Herdes in die Häuser unserer Kunden zu bringen

- создание тёплой атмосферы и тепла домашнего очага в домах наших клиентов

- tvoření teplé atmosféry a dodávání domácího tepla do domů našich zákazníků

- créer une ambiance chaleureuse et fournir la chaleur du foyer dans les maisons de nos clients

- η δημιουργία ζεστής ατμόσφαιρας και η παροχή σπιτικής ζεστασιάς στα σπίτια των πελατών μας

- la creazione di un'atmosfera calda e la consegna del calore del focolare domestico alle case dei nostri Clienti

- crear un ambiente cálido y proporcionar el calor necesario a los hogares de nuestros clientes



- dostarczanie wysokiej jakości produktów w przystępnej cenie  
- stale rozbudowywanie oferty produktowej oraz bieżące odpowiadanie na potrzeby rynku i konsumentów poprzez rozbudowywanie asortymentu

- providing high quality products at affordable prices  
- expanding our product offer and ongoing responding to the needs of the market and consumers through expanding our range of products

- lieferung der Produkte von hoher Qualität und zu mäßigem Preis  
- ständiger Ausbau des Produktangebotes sowie laufende Antworten auf Bedürfnisse des Marktes und der Käufer durch den Ausbau des Warenlagers

- обеспечение высокого качества продукции по доступной цене  
- постоянное расширение торгового предложения и актуальное реагирование на потребности рынка и потребителей за счёт расширения ассортимента

- dodávání vysoce kvalitních výrobků za přístoupnou cenu  
- neustále rozšiřování nabídky výrobků a běžné odpovídání potřebám trhu a spotřebitelů pomocí rozšiřování sortimentu

- fournir des produits de haute qualité à un prix abordable  
- développer toujours notre gamme de produits et répondre aux besoins du marché et des consommateurs en élargissant la gamme

- η παροχή προϊόντων υψηλής ποιότητας σε προσιτές τιμές  
- η μόνιμη ανάπτυξη προσφοράς των προϊόντων, καθώς και η συνεχής ανταπόκριση στις ανάγκες της αγοράς και των καταναλωτών, μέσα από την επέκταση της γκάμας προϊόντων

- la consegna dei prodotti di alta qualità a prezzi convenienti  
- l'ampliamento costante dell'offerta dei prodotti e la risposta costante alle esigenze del mercato e dei consumatori tramite l'aumento della loro gamma

- proporcionar productos de alta calidad a precios asequibles  
- ampliar nuestra gama de productos atendiendo a la demanda del mercado y las necesidades de nuestros clientes



- nieustanna praca nad unowocześnianiem urządzeń  
- rozwijanie technologii produkcji, rozbudowę parku maszynowego oraz zaplecza magazynowego zgodnie z normami ISO

- continuous work on improvement of equipment  
- development of new production technologies, expansion of our machine park and warehouse facilities with the implementation of ISO standards

- ununterbrochene Arbeit an Modernisierung der Anlagen  
- entwicklung neuer Technologien der Produktion, Ausbau des Maschinenparks und des Lagerhinterlandes zusammen mit der Einführung der ISO Norm

- постоянная работа над модернизацией оборудования  
- развитие современных технологий производства, расширение автопарка и складских помещений с внедрением ISO

- neustálá práce na modernizaci zařízení  
- vyvíjení nových technologií, rozšiřování strojového parku a skladových prostor spolu s aplikací normy ISO

- travailler constamment sur l'amélioration de l'équipement  
- développer les nouvelles technologies de production, l'expansion du parc de machines et de l'entrepôt avec la mise en œuvre de l'ISO

- η αδιάκοπη εργασία πάνω στην βελτίωση του εξοπλισμού  
- η ανάπτυξη νέων τεχνολογιών παραγωγής, η επέκταση του μηχανικού εξοπλισμού και των αποθεμάτων με την εφαρμογή του προτύπου ISO

- l'impegno continuo nella modernizzazione degli impianti  
- uno sviluppo delle tecnologie produttive, l'ampliamento del parco di macchine e della struttura di stoccaggio assieme all'attuazione della norma ISO

- trabajar continuamente para mejorar nuestras instalaciones  
- desarrollo de nuevas tecnologías de producción, expansión del parque industrial y de los almacenes con la implantación de los estándares ISO

/ Nos objetivos: / Οι στόχοι μας είναι: / I nostri obiettivi sono: / Nuestros objetivos son:



- budowanie i wzmacnianie pozytywnych relacji z Partnerami Handlowymi, zarówno polskimi, jak i zagranicznymi
- wspieranie wydarzeń i inicjatyw społeczno-kulturowych oraz pomoc charytatywna ukierunkowana na najmłodszych
- building and strengthening positive relationships with business partners, both Polish and foreign ones
- Supporting events and socio-cultural initiatives and charitable aid focused on children
- bau und Stärkung positiver Beziehungen sowohl zu polnischen als auch zu ausländischen Handelspartnern
- unterstützung der Ereignisse und der gesellschaftlich-kulturellen Initiativen sowie Wohltätigkeitshilfe für die Kinder
- построение и укрепление отношений с торговыми партнёрами, как с польскими, так и с зарубежными
- поддержка социально-культурных и мероприятий и инициатив, а также благотворительная помощь наиболее молодым
- budování a posilování pozitivních vztahů s obchodními partnery, jak v Polsku, tak i v zahraničí
- podpora veřejných a kulturních událostí, a iniciativ a dobrovolnická pomoc pro nejmladší
- construire et renforcer des relations positives avec les partenaires d'affaires, à la fois polonais et étrangers
- soutenir des événements et des initiatives socio-culturels et bienfaisance axée sur les enfants
- η οικοδόμηση και η ενίσχυση θετικών σχέσεων με τους εμπορικούς εταίρους, τόσο από την Πολωνία όσο και από το εξωτερικό
- η υποστήριξη εκδηλώσεων και πρωτοβουλιών κοινωνικού και πολιτιστικού χαρακτήρα, καθώς και η φιλανθρωπική βοήθεια σε παιδιά
- la costruzione e l'intensificazione delle relazioni positive con dei partner commerciali, sia polacchi che stranieri
- lo sostegno degli eventi e iniziative sociali e culturali e il supporto a favore dei più giovani
- construir y fortalecer la relaciones con nuestros socios nacionales e internacionales
- apoyar eventos e iniciativas culturales así como campañas benéficas dirigidas a niños

- budowanie wizerunku kominków jako efektywnych, ekonomicznych i ekologicznych urządzeń grzewczych
- creating the image of fireplaces as efficient, economical and ecological heating devices
- imagebildung der Kamine als wirkungsvolle, wirtschaftliche und ökologische Heizanlagen
- создание образа каминов как эффективного экономического, экологического тепло обогревательного оборудовани
- budování image krbů jako výkonných, ekonomických a ekologických topných zařízení
- construire l'image des cheminées comme les appareils de chauffage efficaces, économiques et écologiques
- η οικοδόμηση του προφίλ των τζακιών ως αποδοτικές, οικονομικές και οικολογικές συσκευές θέρμανσης
- la creazione dell'immagine dei caminetti come degli impianti di riscaldamento efficaci, economici e ecologici
- proyectar la imagen de esteras chimeneas como efectivas, económicas y ecológicas

- promowanie idei „Dobre bo polskie”
- creating the image of „Polish product = good product”
- imagebildung „Polnisches Produkt = gutes Produkt”
- построение линии „Польский продукт - хороший продукт”
- budování image „Polský výrobek je dobrý výrobek”
- construire l'image "Produit polonais = produit de qualité"
- η οικοδόμηση της εικόνας „Πολωνικό προϊόν = καλό προϊόν”
- la costruzione dell'immagine „Prodotto polacco = buon prodotto”
- demostrar la calidad del producto polaco

- wyznaczanie standardów i trendów oraz stała ekspansja na nowe rynki zbytu
- setting standards and trends and constant expansion into new markets
- bestimmung von Standards und Trends sowie ständige Eroberung der neuen Absatzmärkte
- определение стандартов и трендов, и постоянное освоение новых рынков сбыта
- stanovení standardů a trendů a neustálá expanze na nové trhy
- définir les normes et les tendances et une constante expansion sur de nouveaux marchés
- ο καθορισμός προτύπων και τάσεων καθώς και η συνεχής επέκταση σε νέες αγορές
- la designazione degli standard e trend e un'espansione costante ai nuovi mercati di sbocco
- establecer estándares, tendencias y constante expansión en nuevos mercados

# Jakość

Quality / Qualität / Качество / Kvalitní / Qualité / Ποιότητα / Qualità / Calidad

Nieustannie starania, bezpośredni kontakt z Klientem końcowym oraz inwestycje w zaplecze produkcyjne pozwoliły zdobyć nam pozycję lidera w branży. Wysoka jakość wyrobów oraz przystępne ceny szybko zdobyły zaufanie i względy odbiorców, a stale poszerzana oferta zwróciła uwagę przyszłych Partnerów Handlowych.

Continuous efforts in direct contact with the end customer and investments in production facilities enabled us to gain the leading position in the industry. The high quality of our products and affordable prices quickly won the trust and favor of customers; and our continuously expanded offer drew the attention of future trading partners.

Ständige Bemühungen, direkter Kontakt mit dem Endkunden sowie Investierung in das Produktionshinterland haben dazu beigetragen, dass wir zum Leader in der Branche geworden sind. Mit hoher Qualität der Produkte sowie mäßigen Preisen haben wir schnell das Vertrauen der Käufer erobert, und dank dem ständig erweiterten Angebot haben wir neue Handelspartner gewonnen.

Непрерывные усилия, непосредственный контакт с конечным клиентом и инвестиции в производственный потенциал позволили нам выйти на лидирующие позиции в отрасли. Высокое качество продукции и доступные цены быстро завоевали доверие и благосклонность клиентов, а постоянное расширение предложения обратило внимание будущих торговых партнеров.

Neustálá snaha, přímý kontakt s konečným zákazníkem a investice do výroby nám umožnily získat pozici lídra v odvětví. Vysoká kvalita výrobků a přístupné ceny rychle získali důvěru a přízeň odběratelů a stále rozšiřovaná nabídka získala pozornost budoucích obchodních partnerů.

Des efforts continus, un contact direct avec le client final et les investissements dans les installations de production nous ont permis de gagner la position de leader dans l'industrie. Les produits de haute qualité et les prix abordables ont rapidement gagné la confiance des clients et l'offre constamment élargie a attiré l'attention de futurs partenaires commerciaux.

Οι συνεχείς προσπάθειες, η άμεση επαφή με τον τελικό πελάτη και οι επενδύσεις στις εγκαταστάσεις παραγωγής μας επέτρεψαν να αποκτήσουμε ηγετική θέση στον σχετικό κλάδο. Η υψηλή ποιότητα των προϊόντων και οι προσιτές τιμές, κέρδισαν γρήγορα την εμπιστοσύνη και την εύνοια των πελατών, ενώ η συνεχής διευρυμένη προσφορά επέστρεψε την προσοχή πολλών μελλοντικών εμπορικών εταιρών.

L'impegno costante, contatto diretto con il Cliente finale e gli investimenti nelle strutture produttive ci hanno consentito di acquisire la posizione del leader nel settore. L'alta qualità dei prodotti e i prezzi convenienti hanno ottenuto subito la fiducia dei destinatari, e l'offerta in un costante ampliamento ha richiamato l'attenzione dei futuri partner commerciali.

Los esfuerzos continuados, el contacto directo con el cliente así como la investigación en la producción, nos han llevado a ser líderes en esta industria. Con un producto de alta calidad y precios asequibles nos hemos ganado rápidamente la confianza de nuestros clientes, y gracias a la continua oferta contamos con la atención de nuevos futuros socios.







# Droga rozwoju...

Corporate progress / Der Entwicklungsweg / Путь развития / Vývoj /  
Développement / Ανάπτυξη / Sviluppo / Desarrollo

Droga rozwoju od niemal garażowej firmy do znanego i cenionego producenta była długa i nie zawsze łatwa. Dała nam jednak ogromną satysfakcję i wiele nas nauczyła.

Dziś oferta kratki.pl jest regularnie prezentowana podczas najważniejszych branżowych wydarzeń i targów. Jesteśmy laureatami wielu prestiżowych nagród i wyróżnień. Dzięki poznaniu branży od podstaw, ukierunkowanej na potrzeby Klienta postawie oraz szybkiemu reagowaniu na zmiany rynkowe, możemy pochwalić się pozycją jednego z czołowych europejskich producentów kominków, a wyroby kratki.pl dostępne są blisko 60 krajach na całym świecie.

The way from a nearly garage company to a well-known and respected manufacturer was long and not always easy.

However, it has given us great satisfaction and we have learned a lot. Today, the offer of Kratki.pl is regularly presented at major industry events and trade fairs. We have won many prestigious awards and distinctions. By understanding the industry from scratch, focusing on customer needs and rapid response to market changes, we can boast of being one of Europe's leading manufacturers of fireplaces and the products of Kratki.pl are available in nearly 60 countries around the world.

Der Entwicklungsweg von einer fast Garagenfirma bis zum bekannten und begehrten Hersteller war lang und nicht immer leicht.

Er gab uns jedoch eine riesige Freude und hat uns viel gelehrt. Heute wird das Angebot von Kratki.pl während der wichtigsten Branchenereignisse und Messen regelmäßig präsentiert. Wir sind Träger von vielen renommierten Preisen und Auszeichnungen. Da wir die Branche vom Anfang an sowie Bedürfnisse der Kunden kennengelernt haben und schnell auf Marktänderungen reagieren, sind wir zu einem führenden europäischen Kaminhersteller geworden, und die Produkte der Firma kratki.pl sind in fast 60 Ländern auf der ganzen Welt zugänglich.

Дорога развития от «гаражной» фирмы к хорошо известному и уважаемому производителю была длинной и не всегда лёгкой.

Тем не менее, дала нам большое удовлетворение и многому нас научила. Сегодня предложение Kratki.pl регулярно представлено на крупных отраслевых мероприятиях и выставках. Мы получили множество престижных наград и отличий. Благодаря пониманию основ отрасли, ориентированию на потребности клиентов и быстрому реагированию на рыночные изменения, мы можем похвастаться тем, что являемся одним из ведущих европейских производителей каминов, а продукция kratki.pl доступна почти в 60 странах мира.

Cesta rozvoje od téměř garážové firmy k známému a vysoce hodnocenému výrobcí byla dlouhá a ne vždy jednoduchá. Dala nám však velkou satisfaci a hodně nás naučila. Dnes je nabídka Kratki.pl pravidelně prezentována během nejdůležitějších událostí a veletrhů v oblasti krbů. Jsme laureátem několika prestižních cen a vyznamenání. Díky tomu, že toto odvětví známe od základů, směřujeme ho na potřeby zákazníka a rychle reagujeme na změny na trhu, můžeme se pochlubit pozicí jednoho z nejlepších evropských výrobců krbů a výrobky Kratki.pl jsou dostupné v téměř 60 zemích na celém světě.

Le développement d'une entreprise de garage au fabricant bien connu et respecté était long et pas toujours facile. Cependant, il nous a donné une grande satisfaction et beaucoup nous a appris. Aujourd'hui, la gamme de Kratki.pl est régulièrement présentée lors des grands événements de l'industrie et des foires commerciales. Nous avons remporté de nombreux prix et distinctions prestigieuses. Par la compréhension de l'industrie à partir de zéro, axée sur les besoins des clients, et par la réponse rapide aux changements du marché, nous pouvons nous vanter d'être l'un des principaux fabricants européens de cheminées et les produits de kratki.pl sont disponibles dans près de 60 pays à travers le monde.

Η διαδρομή προόδου από μια εταιρεία χαμηλού προφίλ σε έναν γνωστό και αναγνωρισμένο κατασκευαστή, ήταν μακρινή και όχι πάντα εύκολη. Μας έδωσε ωστόσο μεγάλη ικανοποίηση και δίδαξε μας πολλά. Αυτή τη στιγμή η προσφορά της εταιρείας Kratki.pl παρουσιάζεται τακτικά στις πιο σημαντικές βιομηχανικές και εμπορικές εκθέσεις. Έχουμε κερδίσει πολλά σημαντικά βραβεία και διακρίσεις. Χάρη στην γνωριμία μας με τον βιομηχανικό κλάδο, που επικεντρώνεται στις ανάγκες του πελάτη και έχει ως βάση την ταχεία ανταπόκριση στις αλλαγές της αγοράς, μπορούμε να νιώθουμε ότι κατέχουμε ηγετική θέση ανάμεσα στους ευρωπαϊκούς κατασκευαστές τζακιών, ενώ τα προϊόντα της kratki.pl είναι διαθέσιμα σε σχεδόν 60 χώρες σε ολόκληρο τον κόσμο.

Il cammino della crescita della ditta posizionata nel garage a un produttore conosciuto ed apprezzato era lunga e non sempre facile. Ci ha dato però un'enorme soddisfazione e ci ha insegnato tanto. Oggi l'offerta di Kratki.pl è regolarmente presentata durante gli eventi del settore e alle fiere. Siamo dei vincitori di tanti premi di prestigio e distinzioni. Grazie alla conoscenza approfondita del settore, dell'atteggiamento indirizzato alle esigenze del Cliente e alla reazione veloce sui cambiamenti del mercato, possiamo vantarsi della posizione di uno dei principali produttori europei di caminetti. I prodotti visualizzabili sito kratki.pl sono disponibili in circa 60 paesi in tutto il mondo.

El camino desde la primera chimenea hecha en un garaje hasta ser un reconocido y popular fabricante ha sido largo y no siempre fácil.

No obstante, nos ha brindado muchas satisfacciones y hemos aprendido mucho. Hoy en día la oferta de Kratki.pl es presentada en casi todos los eventos industriales y de negocios. Somos ganadores de distintos premios y distinciones. El entendimiento de la industria y la rápida capacidad de adaptarnos al mercado nos ha llevado a liderar el mercado europeo y los productos de la firma Kratki están presentes en alrededor de 60 países.

## DODATKOWE OPCJE

Additional options / Zusätzliche Optionen / Дополнительные опции / Dodatečné vybavení: / Options supplémentaires: / Επιπλέον επιλογές: / Opzioni aggiuntive: / Opciones adicionales:



Glass system - zewnętrzna szyba dekoracyjna, która nadaje kominkowi nowoczesny wygląd, optycznie powiększa front wkładu  
System glass - external decorative glass, which gives a fireplace modern look  
Glass-System - ist eine dekorative Außenscheibe, die dem Kamineinsatz ein modernes Design verleiht  
Двойное стекло - внешнее декоративное стекло, которое придает камину современный вид  
Glass systém - zevnější dekorační sklo, působící moderním dojmem, opticky zvětšuje přední stranu krbové vložky  
Systeme glass - vitre extérieure decorative, augmente optiquement la façade de l'insert et lui donne un aspect moderne  
Εξωτερικό διακοσμητικό τζάμι - δίνει μία μοντέρνα πρόσοψη και την μεγαλώνει οπτικά  
Sistema glass - esterno vetro decorativo, che dà moderna sogni Focolare aspetto, sembrano contributo anteriori più grandi  
Sistema Glass - el cristal decorativo exterior le aporta un aspecto moderno al hogar

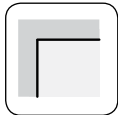

Szyba pyroliza - inaczej zwana szybą samoczyszczącą, która w trakcie palenia w kominku nagrzewa się do temperatur umożliwiających rozkład gromadzonych się na niej zanieczyszczeń (wypala się sadza)  
Pyrolysis glass - also known as self-cleaning glass  
Pyrolyse - Scheibe - anders selbstreinigende Scheibe genannt, die sich beim Brennen im Kamineinsatz bis zu hohen Temperaturen erwärmt und die Zersetzung der sich an dieser Scheibe kumulierten Verschmutzungen ermöglicht. (z.B. Ruß)  
Стекло самоочищением от сажи  
Pyrolitické sklo - jinak řečeno samočisticí sklo, které se během provozu vložky rozehřívá na teplotu umožňující rozklad částic, usazujících se na jeho povrchu (spalují se saze)  
Vitre pyrolyse - c'est une vitre vitrocéramique traitée autonettoyante (une couche très fine et invisible d'oxydes métalliques sur la face extérieure)  
Τζάμι με πυρόλυση - λεγόμενο «αυτοκαθαριζόμενο» τζάμι, προκαλεί ανάπτυξη υψηλής θερμοκρασίας και την καύση των καπναερίων  
Pirólisi di vetro - altrimenti noto come vetro autopulente, che una volta affumicato nel camino riscalda fino a temperature permettendo la distribuzione dell'inquinamento accumulato (brucia fuliggine)  
Cristal pirolítico - Conocido también como cristal autolimpiante

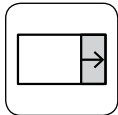

Domykanie drzwiczek - mechanizm zapewniający samoczynne zamykanie się drzwiczek  
Spring for door shutting - automatically closes the door  
Kamintürschließer - Mechanismus, der automatische Türschließung sichert  
Замыкание каминной дверцы - механизм для обеспечения самостоятельного закрытия дверей  
Uzavírání dvířek - mechanismus zajišťující samočinné uzavírání dvířek  
Fermeture automatique de la porte du foyer  
Ελατήριο πόρτας - μηχανισμός, ο οποίος εξασφαλίζει το αυτόματο κλείσιμο πόρτας  
Chiudere la porta - un meccanismo per garantire la chiusura automatica porte  
Sistema de cierre de puerta - Mecanismo automático para el cierre de la puerta

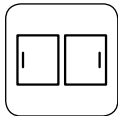

Możliwość przelożenia drzwi ze standardowego prawostronnego otwarcia na lewostronne  
Possibility of changing the doors from the standard, right hand side position to the other side  
Möglichkeit die Tür von rechten Seite im Standard auf links Seite montieren  
Возможность перестановки петель дверцы для лево-или правостороннего открывания  
Možnost změny otevírání dvířek, ze standardního provedení rukojeti na pravé straně na stranu levou  
La capacité à changer l'ouverture de la porte à droite en standard sur la gauche  
Δυνατότητα επιλογής ανοίγματος - κλασικά από δεξιά ή αντίθετα από αριστερά  
La possibilità di modificare dalla destra apertura porta standard sulla mano sinistra  
Posibilidad de cambiar la puerta de lado, de la posición derecha hacia el otro lado

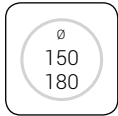

Wylot spalin - możliwość zamontowania wylotów o parametrach: fi 150 lub fi 180  
Exhaust pipe - available diameter: fi 150 or fi 180  
Rauchrohrausgang - es besteht die Möglichkeit, den Kamineinsatz mit 150 oder 180 mm Rauchrohr zu produzieren  
Диаметр дымохода - возможность установки диаметров 150 и 180  
Ústí spalin - možnost montáže ústí kouřových plynů s parametry: Ø150, nebo Ø180  
Sortie de fumées disponible aussi en diamètre: Ø150 et Ø180  
Εξάτμιση καπναερίων - δυνατότητα εφαρμογής εξάτμισης σε διαστάσεις: Φ150 ή Φ180  
Uscita gas scarico - possibilità di montare uscita di parametri Ø150 o di Ø180  
Salida de humos - disponible en diámetro de 150 mm o 180 mm



Podstawa pod wkład - umożliwia bezproblemowe i stabilne ustawienie wkładu przed jego montażem  
Base for inserts - allows stable and smooth setting of an insert  
Untergestell passend zum Kamineinsatz - ermöglicht problemloses und stabiles Aufstellen des Kamineinsatzes vor der Montage  
Подиум для топки - возможность стабильного монтажа топки  
Podstavec pod krbovou vložku - umožňuje bezproblémové a stabilní uložení krbové vložky před namontováním  
Support pour foyer permet de bien positionner le foyer avant l'installation  
Βάση εστίας - διευκολύνει την τοποθέτηση και σταθεροποίηση της εστίας  
Base per il contributo - uper semplificare e stabile regolazione del contributo prima del montaggio  
Base para inserts - permite un montaje fácil y seguro

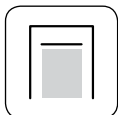

Izolacja wkładu wodnego - dzięki której maksymalna ilość ciepła oddawana jest do instalacji grzewczej  
Isolation for water jacket inserts - reduces heat loss from a fireplace insert with water jacket  
Isolierung des wasserführenden Kamineinsatzes, dank der die Wärme optimal an die ZH abgegeben wird  
Изоляционный материал для топки - аккумулирует тепло  
Izolace teplovodní vložky - díky které je předáváno do topné instalace maximální množství tepla  
Isolation thermique pour foyer chaudière - grâce à elle la quantité maximale de chaleur est rendue dans l'installation de chauffage

Μόνωση εστίας καλοριφέρ - χάρη στην οποία η ψηλότερη θερμοκρασία μεταφέρεται στο κύκλωμα θέρμανσης  
Isolamento del contributo dell'acqua - grazie alla massima quantità di calore viene restituito al sistema di riscaldamento  
Aislamiento para inserts con intercambiador de agua - se reduce la pérdida del calor del hogar

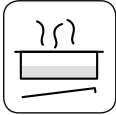

Bio wkładka - specjalna nakładka, umieszczana w kominku w miejsce rusztu, która umożliwia delektowanie się widokiem ognia nawet w gorące letnie dni, przy czym, w tym przypadku kominek nie oddaje ciepła, tylko spełnia funkcje typowo dekoracyjne. Bio wkładka jest zasilana płynem Bio-deco

Bio-insert - should be placed inside a fireplace instead of a grate. Bio-insert lets to enjoy a fire view even in warm summer evenings. But in this case it does not create warmth. It can only be used for decorative purposes. It is powered by a special liquid bio-deco

Bio-Einsatz - spezieller Aufsatz, den man anstelle des Kaminfeuerrostes platziert, dieser Aufsatz ermöglicht einen Feueranblick auch an sonnigen Tagen, somit gibt der Kamineinsatz kaum Wärme ab und dient nur dekorativen Zwecken. In dem Bio-Einsatz wird ein spezieller Bio-Deco-Brennstoff verwendet.

Вкладыш для биокамина - специальное устройство помещается в камине в месте решётки, которая позволяет наслаждаться видом огня в летние дни. Вкладыш не отражает тепла, это только декоративный элемент. Для вкладыша используется жидкость Bio-deco

Biovložka - speciální vložka, která se vkládá do krbu místo roštu, umožňující pokochat se pohledem na živý plamen dokonce i v horké letní dny, v tomto případě krb netopí, nýbrž plní pouze dekorativní funkci. biovložka je plněná kapalinou bio-deco.

Bio-insert pour foyers - insert spécial adapté à nos foyers, qui peut remplacer la grille du foyer en été (fonction décorative) Combustible: Bio-deco (l'éthanol)

Βιοένθετο -Ένα ειδικό ένθετο που τοποθετείτε στην θέση της σχάρας και μας επιτρέπει να απολαμβάνουμε την φωτιά ακόμη και στις ζεστές ημέρες, δεν αντανακλά τη θερμότητα και η λειτουργία της είναι καθαρά διακοσμητική.Το βιοένθετο τροφοδοτείται από υγρό bio-deco

Bio inserire - una sovrapposizione di speciale che viene inserito nel camino griglia sul posto che permette di godere la vista del fuoco, anche nelle calde giornate estive, e, in questo caso, il camino non riflette il calore, di solito risponde solo le caratteristiche decorative di AD. Bio wkładka è alimentato da un liquido Bio-deco

Hogares-bio - Puede colocarse dentro de la chimenea en el lugar donde se sitúa la rejilla del insert. Los hogares bio están diseñados para disfrutar de la visión de fuego incluso en cálidas noches de verano, ya que su función es meramente decorativa. Precisa combustible especial bio-etanol

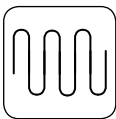

Wężownica - miedziana rurka wbudowana w kominek z płaszczem wodnym, służy głównie jako zabezpieczenie przed przegrzaniem - króciec wejścia/wyjścia 1/2"

Coil pipe - special copper pipe which is built inside a fireplace insert with water jacket. It is protecting a fireplace from overheating.

Input/Output connector - 1/2"

Змеевик - Специальная медная трубка встроенная в топку с водяным контуром которая может применяться как для производства теплой хозяйственной воды, так и для предохранения топки от перегрева тоже в случае отсутствия электрической энергии.

Sicherheitswärmetauscher - spezielles im Wassermantel des Kamineinsatzes eingebautes Kupferrohr, das einerseits warmes Brauchwasser erzeugt, andererseits die Anlage vor Überhitzung schützt - Ein-/Ausgangsstutzen 1/2"

Chladící smyčka - měděná trubka vestavěná do krbu s vodním pláštěm, slouží především jako pojištění proti přehřátí, dodečně může být využita jako zdroj teplé užitkové vody - nátrubek vstupu/výstupu 1/2"

Serpentin pour foyer chaudière - c'est un tube en cuivre en spirale servant de protection contre la surchauffe; il peut également être employé dans la production d'eau chaude (tubulure d'arrivée/d'évacuation 1/2")

Σπирάλ ασφαλείας - χαλκινός σωλήνας ενσωματωμένος στην εστία, λειτουργεί ως βασική ασφάλεια και προστατεύει από υπερθέρμανση, επιπλέον μπορεί να εκμεταλλευτεί ως πηγή ζεστού νερού χρήσης

Serpentina - Tubo di rame costruito nel camino con una giacca d'acqua, che possono essere utilizzati per produrre sia acqua calda e per proteggere il focolare dal surriscaldamento - connettore I/O 1/2"

Intercambiador de calor de seguridad - Especial tubo de cobre que por un lado proporciona agua caliente sanitaria y por el otro evita el sobrecalentamiento del sistema. Conexión de 1/2"

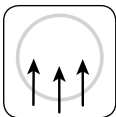

Dolot powietrza - króciec montowany do wkładu kominkowego, który ma na celu doprowadzenie świeżego powietrza do paleniska z zewnątrz budynku - dodatkowa opcja

External air inlet - special connector mounted in fireplace insert, which provides fresh air directly from outside - additional option

Externluftzufuhr - spezieller Stutzen, der am Kamineinsatz eingebaut wird, um frische Luft von außen für den Verbrennungsprozess zuzuführen - zusätzliche Option

Приток воздуха - Устройство для подвода воздуха в камеру сгорания - дополнительный выбор

Přívod externího vzduchu - nástavec montovaný v krbové vložce, má za úkol přivádění čerstvého vzduchu do topeniště z vnějšku budovy

Entrée d'air d'extérieur - Tubulure spéciale intégrée avec le foyer qui fournit l'air extérieur à la chambre de combustion

Εξάρτημα, χάρη στο οποίο γίνεται εισαγωγή εξωτερικού αέρα στον θάλαμο καύσης

ingresso aria - connettore montato inserto camino, che mira a portare aria fresca nella fornace dall'esterno dell'edificio

Toma de aire exterior - Conector especial montado en la chimenea que proporciona aire fresco directamente del exterior - opcional



Kominek idealny do domów z rekuperatorami  
 Ideal for homes with heat recovery units  
 Der ideale Kamin zu den Häusern mit den Abhitzeverwerter  
 Идеально подходит для домов с энергосберегающими технологиями  
 Ideální pro domy s rekuperačními  
 Cheminée idéal pour les maisons avec récupérateurs  
 Ιδανική εστία για τα πράσινα σπίτια  
 Il camino ideale per le case passive  
 Ideal para los hogares con tecnologías de ahorro energético



Wkład kominkowy spełnia normy BlmschV 2  
 Fireplace insert meets BlmschV 2 norms and regulations  
 Kamineinsatz erfüllt die BlmschV Stufe 2  
 Каминная топка соответствует нормам BlmschV 2  
 Krbová vložka splňuje BlmSchV 2  
 L'insert répond le BlmschV 2  
 Η εστία πληροί προδιαγραφές της νόρμας BlmschV 2  
 Inserto rispetta le norme BlmschV 2  
 Insertables que cumplen con las normas BlmschV

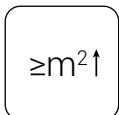

≥ 700 cm<sup>2</sup>

≥ 900 cm<sup>2</sup>

≥ 1000 cm<sup>2</sup>

Minimalne wymagane pole czynne kratki wylotowych / Recommended ventilation area of the air outlet grid / Mindest Luftdurchsatz von Abluftgitter / Рекомендуемая активная площадь (поле) решетки на выходе

Doporučená plocha průřezu výstupních ventilačních mřížek / Section de passage d'air minimal requise pour les grilles d'aération de sortie / προτεινόμενη επιφάνεια λειτουργείας περσίδας εξόδου / Campo attivo delle griglie d'uscita consigliato

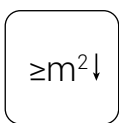

≥ 500 cm<sup>2</sup>

≥ 700 cm<sup>2</sup>

≥ 800 cm<sup>2</sup>

Minimalne wymagane pole czynne kratki wlotowych / Recommended ventilation area of the air intake grid / Mindest Luftdurchsatz von Zuluftgitter / Рекомендуемая активная площадь (поле) решетки на входе

Doporučená plocha průřezu vstupních ventilačních mřížek / Section de passage d'air minimal requise pour les grilles d'aération d'entree / προτεινόμενη επιφάνεια λειτουργείας περσίδας εισόδου / Campo attivo delle griglie d'ingresso consigliato / Superficie de ventilación recomendada de la entrada de aire / Superficie de ventilación recomendada de la salida de aire

## OZNACZENIA STOSOWANE W KATALOGU

Symbols used in catalogue / Die Bezeichnung im Katalog / Назначение используемые в каталоге / Označení používaná v katalogu: / Description des symboles / Σύμβολα, που χρησιμοποιηθήκαν στον κατάλογο / Simboli usati nel catalogo / Símbolos usados en el catálogo



Мощь номинальна (kW) / Power rating (kW) / Nominalleistung (kW) / Мощность (кВт) / Jmenovitý výkon (kW) / Puissance nominale (kW) / Ονομαστική ισχύς (kW) / Potenza nominale (kW) / Potencia nominal (kW)



Zakres mocy grzewczej (kW) / Range of power rating (kW) / Leistungsbereich (kW) / Диапазон мощности нагрева (кВт) / Rozsah výkonu (kW) / Gamme de puissance de chauffage (kW) / Το εύρος της θερμικής ισχύος σε (kW) / Potenza termica nominale (kW) / Rango de potencia (kW)



Sprawność cieplna (%) / Efficiency (%) Wirkungsgrad (%) Тепловая мощность (%) Tepelná účinnost (%) Rendement (%) Θερμική απόδοση (%) Tipo di combustibile (%) Rendimiento (%)

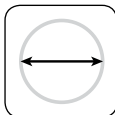

Średnica czopucha (mm) / Diameter (mm) / Rauchrohrdurchmesser (mm) / Диаметр дымохода (мм) / Průměr sopouchu (mm) / Tubage (mm) / Διάμετρος εξαγωγής καυσαερίων (σε χιλιοστά) / Diametro canna fumaria (mm) / Priemer dymovodu (mm) / Diámetro (mm)



Średnia moc z wody (kW) / The average power of the water (kW) / Durchschnittliche Leistung wasserseitig (kW) / Средняя мощность воды (кВт) / Jmenovitý výkon do vody (kW) / Puissance moyenne de l'eau (kW) / Μέσος όρος απόδοσης στο νερό (kW) / Media della potenza di acqua (kW) / Potencia media del agua (kW)

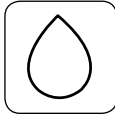

Pojemność wody (l) / Capacity of water (l) / Wasserinhalt (l) / Емкость воды (л) / Objem výměníku (l) / Contenance d'eau (l) / Χωρητικότητα νερού / Quantità d'acqua (l) / Capacidad del agua (l)

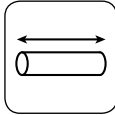

Długość polan (mm) / Length of wood (mm) / Holzscheitlänge (mm) / Длина поленьев (мм) / Délka polen (mm) / Taille des bûches (mm) / Μήκος καύσιμης ύλης (χιλιοστών) / Lunghezza pezzi di legno (mm) / Combustible

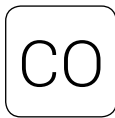

CO - Emisja (przy 13% O<sub>2</sub>) ≤ podawana w % / CO - Emission (with 13% O<sub>2</sub>) ≤ Given in percent / CO - Emmission (bei 13% O<sub>2</sub>) ≤ angegeben in % / CO - Эмиссия (при 13% O<sub>2</sub>) ≤ дано в процентах / CO - emise (při 13% O<sub>2</sub>) ≤ udávána v% / CO - Emission de (13% O<sub>2</sub>) ≤ présentée en pourcentage CO - εκπομπή (σε 13% O<sub>2</sub>) ≤ στα% / CO - Emissione (presso 13% O<sub>2</sub>) ≤ dato in% / Emisiones CO (con 13% O<sub>2</sub>) ≤ Datos en %



Emisja pyłków (mg/Nm<sup>3</sup>) / Pollen emmission (mg/Nm<sup>3</sup>) / Feinstaubemission (mg/Nm<sup>3</sup>) / Эмиссия СО (mg/Nm<sup>3</sup>) / Pylová emise (mg/Nm<sup>3</sup>) / Émissions de pollen (mg/Nm<sup>3</sup>) / Εκθεση γύρης (mg/Nm<sup>3</sup>) / Emissione di polline (mg/Nm<sup>3</sup>) / Emisión de polen (mg/Nm<sup>3</sup>)

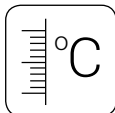

Temperatura spalin (°C) / Temperature (°C) / Abgastemperatur (°C) / Температура (°C) / Teplota spalin (°C) / Température des fumées (°C) / Θερμοκρασία καυσαερίων (°C) / Temperatura dei gas di scarico (°C) / Temperatura (°C)

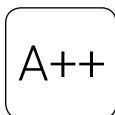

Klasa energetyczna / Efficiency class devices / Energieklasse / Энергетический класс / Zařízení třídy účinnosti / Appareils de classe d'efficacité / Συσκευές κλάσης απόδοσης / Dispositivi di classe di efficienza / Dispositivos de clase de eficiencia



Ciśnienie robocze (bar) / Working pressure (bar) / Betriebsdruck (bar) / Рабочее давление (bar) / Tlak (bar) / La pression du circuit (bar) / πίεση (bar) / Pressione (bar) / Presión de trabajo (bar)



Współczynnik efektywności energetycznej EEI / The energy efficiency index EEI / Energieeffizienzindex EEI / Индекс энергоэффективности EEI / Index energetické účinnosti EEI / L'indice d'efficacité énergétique EEI / Ο δείκτης ενεργειακής απόδοσης EEI / Indice di efficienza prodotto EEI / El índice de eficiencia energética EEI

## WYPOSAŻENIE WKŁADÓW POWIETRZNYCH

Advantages of traditional fireplace inserts / Die Vorteile der traditionellen Kamineinsatz / Преимущества традиционных топок / Přednosti vložek řady BS gilotina / Avantages des foyers BS avec porte relevable / Πλεονεκτήματα εστιών τύπου BS αυρόμενη πόρτα / Vantaggi focolare con linea ghigliottina BS / Ventajas de los hogares tradicionales

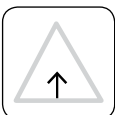

Wysoki czopuch - zwiększa powierzchnię wymiany ciepła pomiędzy gorącymi spalinami a pomieszczeniem / High flue - increases the area of heat exchange between the hot exhaust gases and the room / Hoher Kaminfuchs - vergrößert die Heizfläche / Высокий дымоход - увеличивает поверхность теплообмена между горячими выхлопными газами и комнатой / Vysoký sopouch, zvětšuje plochu výměny tepla mezi horkými spalinami a místností / Partie supérieure du foyer (l'avaloir des fumées) - augmente la surface d'échange de chaleur entre les fumées chaudes et l'air environnement / Κωνικός εναλλάκτης καυσαερίων εστίας. Μεγαλώνει την επιφάνεια εναλλαγής θερμών καυσαερίων από τον θάλαμο καύσης προς τον εξωτερικό χώρο της εστίας / Camino alto - deve aumentare l'area superficiale scambio termico nel focolare con camicia d'acqua / Cabezal alto - incrementa el area de intercambio de calor entre la salida de gases y el ambiente

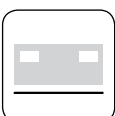

Deflektor - wydłuża drogę spalin / Deflector - extends the exhaust path / Deflektor - verlängert den Abgasweg / Встроенный дефлектор/дефлектор / Deflektor - prodlužující dráhu kouřových plynů / Déflecteur - allonge le trajet des fumées / Κόφτης, προκαλεί εκτροπή των καυσαερίων / Deflettore aumento percorso fum / Deflector - para alargar el circuito de humos

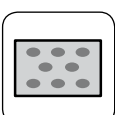

Ruchomy ruszt, dzięki któremu można łatwo wymieść popiół / Movable grate gives possibility of easily wipe away the ash / Beweglicher Rost hilft beim Reinigen / Движущиеся решетка благодаря которой Вы можете легко стереть пепел / Vymetelný rošt umožňující snadné vymetání popelu / Grille de foyer amovible pour faciliter l'évacuation des cendres / Grille de foyer amovible pour faciliter l'évacuation des cendres / Αφαιρούμενη σχάρα, διευκολύνει τον καθαρισμό της εστίας / Griglia mobile, grazie alla quale può essere facilmente pulito cenere / Parrilla móvil para facilitar la limpieza de las cenizas

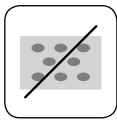

Wkład bezrusztowy - dopalanie na popiele / Fireplace without grate - the combustion takes place over the entire width of the fireplace / Brenkammer ohne Rost- Ascheabbrennung / Безрешетчатая вставка – дожигание пепла / Bezroštová vložka – dodatečné spalování na popelu / Il n'y a pas de grille à cendre - la combustion a lieu sur toute la surface de la chambre de combustion / Είναι χωρίς σχαράκι και σурτάρι στάχτης - η καύση υψηλών θερμοκρασιών ελαττώνει σημαντικά την δημιουργία στάχτης / L'inserto senza griglia - brucia in cenere / Cámara de combustión sin rejilla - combustión de las cenizas

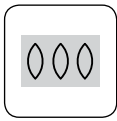

Ozdobna płyta tylna / Decorative back plate / Dekorative hintere Platte / Декоративная задняя плита / Dekorativní zadní deska / Paroi arrière décorative / Διακοσμητική πλάκα / Piastra dietro decorativo / Placa posterior decorativa

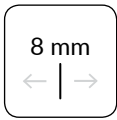

Ścianki paleniska o minimalnej grubości 8 mm gwarantują bezawaryjne działanie paleniska / Fireplace with a minimum wall thickness of 8 mm, guarantee a trouble-free operation of the fireplace / Wanddicke des Einsatzes 8mm garantiert einen störungsfreien Betrieb des Ofens / Минимальная толщина стенки 8 мм обеспечивают бесперебойной работу / Stěny ohniště s minimální tloušťkou 8 mm zaručují bezporuchovou funkci ohniště / Les parois d'épaisseur minimale de 8mm garantissent le fonctionnement optimal du foyer / Τοιχώματα εστίας πάχους 8μμ, εξασφαλίζουν άψογη λειτουργία / Pareti del forno uno spessore minimo di 8 mm garantire un funzionamento senza problemi del camino / Espesor de pared de 8 mm, para garantizar un buen funcionamiento de la chimenea



Gęsto rozmieszczone radiatory - dzięki nim kominek przekazuje więcej ciepła do otoczenia / Densely arranged radiators give more heat to the room / Dicht aneinander liegende Radiatoren, dadurch gibt der Kamineinsatz mehr Wärme in den Raum ab / Часто расположенные радиаторы - благодаря которым камин передает больше тепла / Hustě rozmístěné radiátory - díky čemuž krb odevzdává více tepla do okolí / La présence d'un grand nombre d'ailettes de diffusion renvoie plus de chaleur dans la pièce / Плотнo тоποθετημένοι εναλλάκτες, προκαλούν μεγαλύτερη απόδοση θερμότητας / Forte densità distribuiti del radiatore - grazie lui focolare trasmette più calore l'ambiente / Elementos de irradiación que ofrecen un aumento del calor en el ambiente

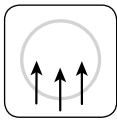

Dolot powietrza - króciec montowany do wkładu kominkowego, który ma na celu doprowadzenie świeżego powietrza do paleniska z zewnątrz budynku - dodatkowa opcja / External air inlet - special connector mounted in fireplace insert, which provides fresh air directly from outside - additional option / Externluftzufuhr - spezieller Stutzen, der am Kamineinsatz eingebaut wird, um frische Luft von außen für den Verbrennungsprozess zuzuführen - zusätzliche Option / Приток воздуха - Устройство для подвода воздуха в камеру сгорания - дополнительный выбор / Přívod externího vzduchu - nástavec montovaný v krbové vložce, má za úkol přivádění čerstvého vzduchu do topeniště z vnějšku budovy / Entrée d'air d'extérieur - Tubulure spéciale intégrée avec le foyer qui fournit l'air extérieur à la chambre de combustion / Εξάρτημα, χάρη στο οποίο γίνεται εισαγωγή εξωτερικού αέρα στον θάλαμο καύσης / Ingresso aria - connettore montato inserto camino, che mira a portare aria fresca nella fornace dall'esterno dell'edificio / Entrada de aire del exterior - conector especial montado en la chimenea para conectar la entrada de aire de combustión del exterior - opción adicional

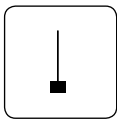

Regulowane nóżki ułatwiający wy poziomowanie wkładu / Adjustable legs for leveling a fireplace / Regulierbare FüÙe erleichtern das richtige Aufstellen des Kamineinsatzes / Регулируемые ножки, которые облегчают выравнивание топки / Patas regulables para facilitar la instalación / Regulované noÙky usnadňující nastavení krbové vložky do vodorovné polohy / Jambes réglables facilitant le positionnement correct du foyer / Ρυθμιζόμενα ποδαράκια, διευκολύνουν το αλφάδιασμα εστίας / Piedini regolabili per la facilità di focolare / Patas regulables para facilitar la instalación

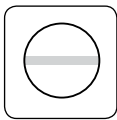

Wbudowany szyber reguluje siłę ciągu komina / Built-in damper regulates the strength of the chimney draft / Eingebauter Schieber dank dem der Kaminzug regulierbar ist / Встроенный шибер / Vestavěná klapka reguluje tah komína / Buse (sortie des fumées) intégrée - permet de régler la „force“ du tirage / Ενσωματωμένο κλαπέτο καμινάδας, το οποίο ρυθμίζει τον ελκυσμό της / Ενσωματωμένο κλαπέτο καμινάδας, το οποίο ρυθμίζει τον ελκυσμό της / Integrato serranda fumo regola l'intensità ll tiraggio della canna fumaria / Trampilla movible para regular la combustión

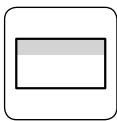

Kierownica powietrza tworząca system czystej szyby - ograniczający osadzanie się sadzy na szybie / Air clean glass-forming system - limits the deposition of soot on the glass / Luftmantel an der Frontscheibe - verringert die Rußablagerung an der Scheibe / Управление воздухом, система чистого стекла / Přívod vzduchu na sklo pro systém čistého skla - slouží k zamezení usazování sazí na skleněné tabuli / Système „vitre propre“ par rideau d'air - atténue la suie sur la vitre / Αεροκουρτίνα, αποτρέπει το μαύρισμα τζακιού / Sterzo aria creazione sistema pulito vetri - limitativo sedimentazione nerofumo sul vetro / Sistema de limpieza del cristal - evita que se depositen hollín en el cristal



Ceramika żaroodporna wytrzymująca temperaturę do 800°C / Heat-resistant ceramic can withstand temperatures up to 800°C / Hitzbeständige Keramikscheibe bis 800 Grad / Жароупорное стекло выдерживающие температуру до 800 градусов / Žáruvzdorné sklo odolné proti teplotě do 800°C / Vitre réfractaire supporte la température jusqu'à 800°C / Πυράντοχο τζάκι, έως 800°C / Vetro resistente al calore in grado di sopportare temperature fino a 800 gradi / Cristal resistente a temperatura de 800°C

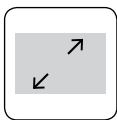

Duża komora spalania / Large combustion chamber / GroÙer Brennraum / Большая камера сгорания / Velká spalovací komora / Grande chambre de combustion / Μεγάλος θάλαμος καύσης / Camera di combustione grande / Amplia cámara de combustión

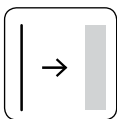

System zimnej kłamki umożliwia zdjęcie kłamki w momencie palenia w kominku / The system of cold handle allows to take it off during the combustion process / System des kalten Griffes ermöglicht während des Brennvorgangs den Griff abzunehmen / Система холодной ручки / Systém studené kliky umožňuje sundání kliky při topení v krbu / Système de poignée froide - possibilité d'enlever la poignée pendant la combustion dans le foyer / Αφαιρούμενο πόμολο κατά την διάρκεια λειτουργίας τζακιού, για να προστατευτεί από υπερθέρμανση / Il sistema la maniglia fredda è possibile rimuovere la maniglia al momento della combustione nel focolare / Maneta fría extraíble

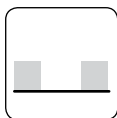

Ozdobny płotek zabezpiecza drewno przed wypadaniem z wkładu / Decorative fence protects the wood from falling out of the insert / Dekorzaun, der das Holz vom Herausfallen schützt / Заборчик защищает древесину от выпадения из топок / Dekorativní ohradník zajišťuje dříví proti vypadnutí z krbové vložky / Pare - bûches décoratif empêche les bûches de tomber du foyer / Διακοσμητική ασφάλεια, προστατεύει τα ξύλα να παραμένουν στον θάλαμο καύσης / Ostacolo decorativo protegge il legno di cadere fuori della focolare / Murillo que evita la caída de la leña fuera del insert

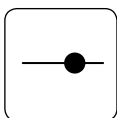

Regulacja dopływu powietrza do spalania / Regulation of air supply for combustion / Regulieren des Luftstroms durch die Aschenschublade / Регулирование притока воздуха через вынимаемый пеплосборник / Regulace přívodu vzduchu skrz popelník (primárního ke spalování) / Réglage d'arrivée d'air pour la combustion / Ρύθμιση εισαγωγής αέρα μέσω του σταχτοδοχείου (πρωτογενής καύσης) / Regolazione dell'aria primaria per la combustione / Regulación del suministro de aire para la combustión

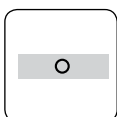

Szuflada/pojemnik na popiół, gdzie gromadzą się pozostałości po spalonym drewnie / Ash drawer/container where remains burnt wood / Aschenschublade in derer sich der Rest des verbrannten Holzes sammelt / Ящик/контейнер для пепла - здесь собираются остатки дров / Zásuvka na popel, ve které se shromažďují zbytky spáleného dříví / Tiroir à cendres sert à collecter les résidus de combustion / Συρτάρι στάχτης, διοχετεύει υπολείμματα μετά την καύση / Cassetto per cenere che si accumulano in resti di legno bruciato / Cajón cenicero - contenedor de brasas

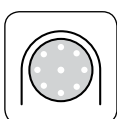

System unoszenia drzwi / Lift-up door system / System der Türanhebung / Тросовой механизм поднятия гильотины, тросовой механизм поднятия гильотины скольжения дверцы / Systém výsuvu dvířek nahoru / Système pour soulever la porte / Σύστημα συρόμενης πόρτας / Sistema alzare porta / Sistema para la puerta de guillotina

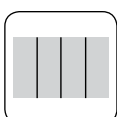

Acumotte - materiał akumulujący ciepło, który podwyższa temperaturę w komorze podnosząc efektywność spalania. / Acumotte - heat accumulating material that increases the temperature in the chamber, increasing the efficiency of combustion. / Acumotte - Wärmespeichermaterial, das die Temperatur in der Kammer erhöht und die Effizienz der Verbrennung erhöht. / Acumotte - теплонакопительный материал, который увеличивает температуру в камере, повышая эффективность сгорания / Acumotte - tepelně akumulační materiál, který zvyšuje teplotu v komoře a zvyšuje účinnost spalování. / Acumotte - matériau d'accumulation de chaleur qui augmente la température dans la chambre, ce qui augmente l'efficacité de la combustion. / Acumotte - υλικό συσσώρευσης θερμότητας που αυξάνει τη θερμοκρασία στο θάλαμο, αυξάνοντας την απόδοση της καύσης. / Acumotte - materiale che accumula calore che aumenta la temperatura nella camera, aumentando l'efficienza della combustione.

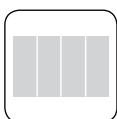

Termotec - materiał akumulujący ciepło, który podwyższa temperaturę w komorze podnosząc efektywność spalania. / Termotec - heat accumulating material that increases the temperature in the chamber, increasing the efficiency of combustion. / Termotec - Wärmespeichermaterial, das die Temperatur in der Kammer erhöht und die Effizienz der Verbrennung erhöht. / Termotec - теплонакопительный материал, который увеличивает температуру в камере, повышая эффективность сгорания / Termotec - tepelně akumulační materiál, který zvyšuje teplotu v komoře a zvyšuje účinnost spalování. / Termotec - matériau d'accumulation de chaleur qui augmente la température dans la chambre, ce qui augmente l'efficacité de la combustion. / Thermotec - υλικό συσσώρευσης θερμότητας που αυξάνει τη θερμοκρασία στο θάλαμο, αυξάνοντας την απόδοση της καύσης. / Termotec - materiale che accumula calore che aumenta la temperatura nella camera, aumentando l'efficienza della combustione.

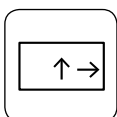

Podwójny system otwierania drzwi / Dual system of door opening / Doppeltes Sytems der Türöffnung / двойная система открывания и закрывания двери / Dvojit způsob otevírání dvířek / Double système d'ouverture de porte / Διπλό σύστημα ανοίγματος πόρτας / Doppio sistema di apertura della porta / Doble sistema de apertura de la puerta

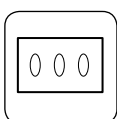

System dopalania spalin - ogranicza emisję szkodliwych substancji do środowiska / Post-combustion flue gas system - reduces emissions of harmful substances into the environment / Zusätzliche Verbrennung der Abgase - verringert die Emissionen der schädlichen Substanzen in die Atmosphäre / Система дожигания выхлопных газов - Ограничение выбросов вредных веществ для окружающей среды / Systém přidavného spalování zplodin hoření (omezuje emisi škodlivých látek do ovzduší) / Système de double combustion - limite l'émission de substances nocives dans l'environnement / Σύστημα δευτερογενής καύσης (περιορίζει την εκπομπή καπναερίων στην ατμόσφαιρα) / Il sistema combustione di gas di scarico - riduzione delle emissioni di sostanze nocive all'ambiente / Post-combustión - combustión adicional que reduce las emisiones de sustancias nocivas en el medio ambiente

# MBM/PF



≥ 700 cm<sup>2</sup>

≥ 500 cm<sup>2</sup>



<b>kW</b>	<b>&lt;kW&lt;</b>			<b>CO</b>
10	4,5-12,5	~81%	200	0,1%
<b>PM</b>				<b>EEl</b>
28	235	161	535x413	106,71

Wyposażenie/Equipment/Ausstattung/Оборудование/  
 Vybavení/Equipement/Εξοπλισμός/Attrezzatura/Equipamiento:

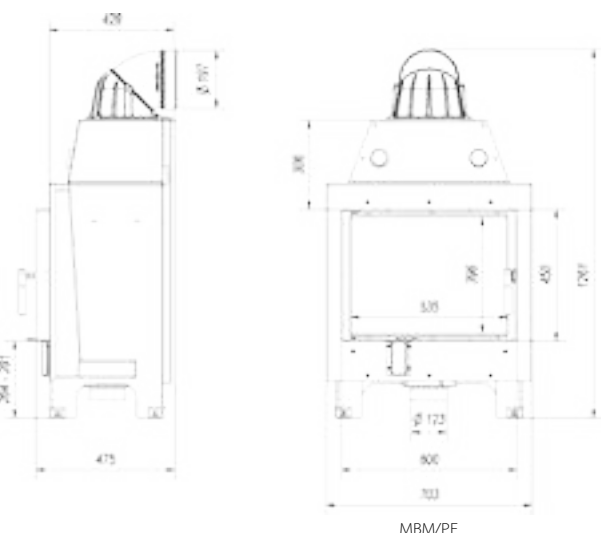
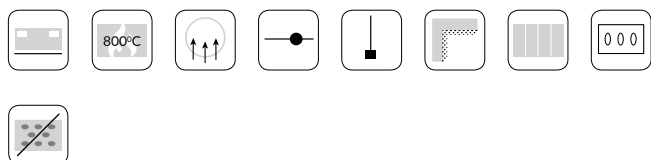

MBM/L/BS



MBM/P/BS



MBM/G



MBM/L/BS/G



MBM/P/BS/G





MBZ PF

# MBZ/PF



≥ 900 cm<sup>2</sup>

≥ 700 cm<sup>2</sup>



kW

13

<kW<

6-16



~81%



200

CO

0,09%

PM

27

°C

235

kg

185



584x458

EEl

106,71

Wyposażenie/Equipment/Ausstattung/Оборудование/  
 Vybavení/Equipement/Εξοπλισμός/Attrezzatura/Equipamiento:

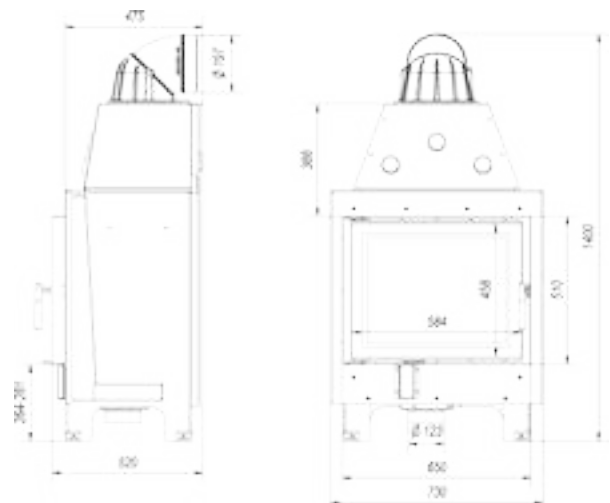

MBZ/PF



MBZ/L/BS



MBZ/P/BS



MBZ/G



MBZ/L/BS/G



MBZ/P/BS/G

# MBO/PF



≥ 900 cm<sup>2</sup>

≥ 700 cm<sup>2</sup>



kW	<kW<			CO
15	6-18	~83%	200	0,10%

PM				EEl
7	210	214	686x458	109,30

Wyposażenie/Equipment/Ausstattung/Оборудование/  
 Vybavení/Equipement/Εξοπλισμός/Attrezzatura/Equipamiento:

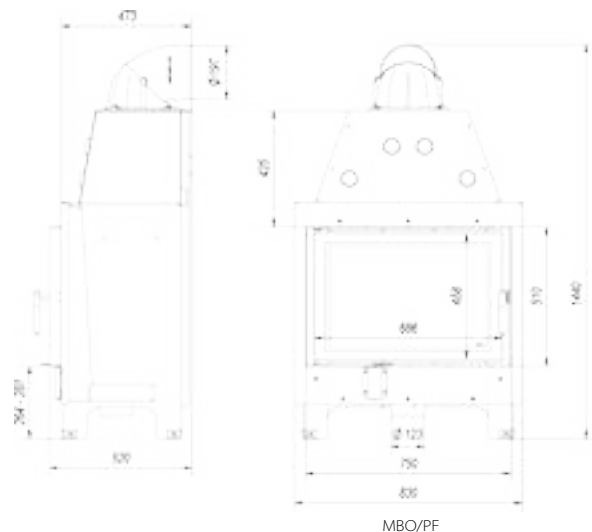
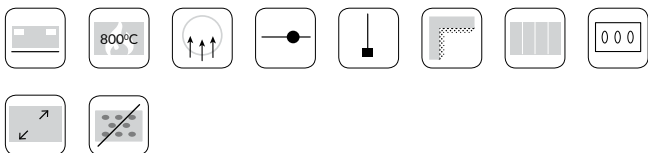



MBO BS L

# MBA/PF



≥ 900 cm<sup>2</sup>

≥ 700 cm<sup>2</sup>



17



9-19,5



~86%



200



0,09%



8



201



222



686x518



113,20

Wyposażenie/Equipment/Ausstattung/Оборудование/  
 Vybavení/Equipement/Εξοπλισμός/Attrezzatura/Equipamiento:

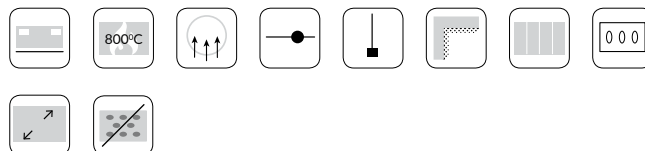

MBA/L/BS



MBA/P/BS



MBA/G



MBA/L/BS/G



MBA/P/BS/G

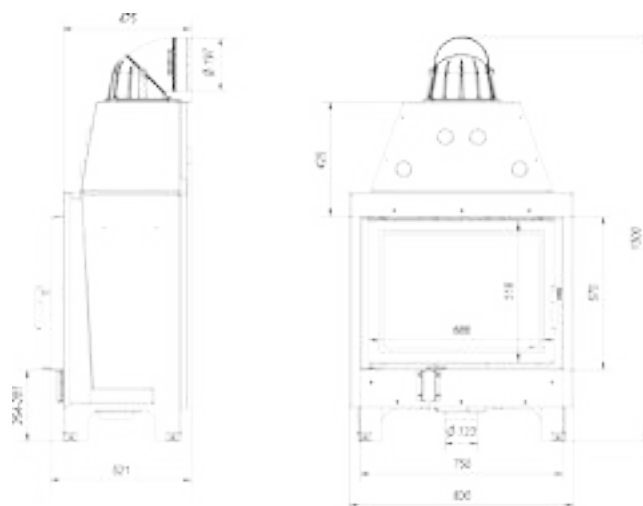

MBA/PF

# MB100/G



≥ 900 cm<sup>2</sup>

≥ 700 cm<sup>2</sup>



kW	<kW<			CO
14	6-17	~82%	200	0,10%

PM				EEl
27	220	327	955x296	108,01

Wyposażenie/Equipment/Ausstattung/Оборудование/  
 Vybavení/Equipement/Εξοπλισμός/Attrezzatura/Equipamiento:

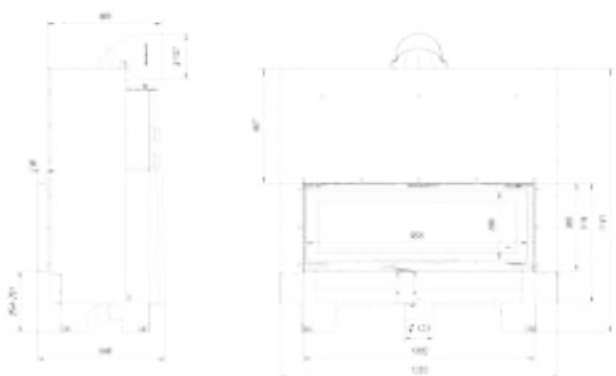
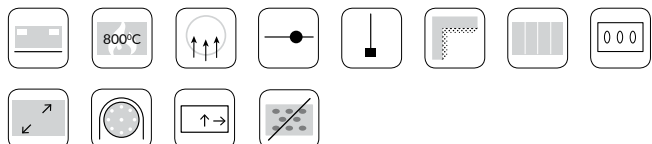

MB100/G





# MB120/G



≥ 1000 cm<sup>2</sup>

≥ 800 cm<sup>2</sup>



kW	<kW<			CO
22	10-27	~80%	200	0,10%
PM				EEl
11	240	396	1155x366	105,40

Wyposażenie/Equipment/Ausstattung/Оборудование/  
 Vybavení/Equipement/Εξοπλισμός/Attrezzatura/Equipamiento:

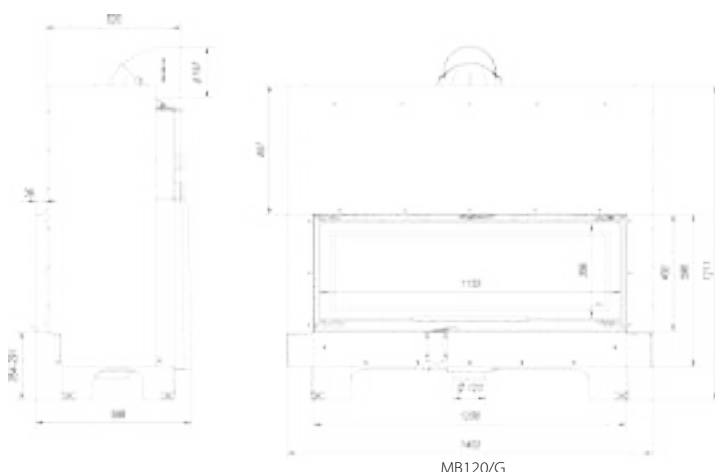
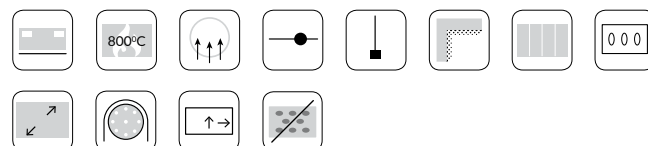

MB 120 G

MB120/G

MBN



MBN/P/BS



≥ 700 cm<sup>2</sup>

≥ 500 cm<sup>2</sup>



kW	<kW<			CO
8	4-11	~80%	200	0,10%

PM				EEI
21	255	159	451x456	105,40

Wyposażenie/Equipment/Ausstattung/Оборудование/  
 Vybavení/Equipement/Εξοπλισμός/Attrezzatura/Equipamiento:

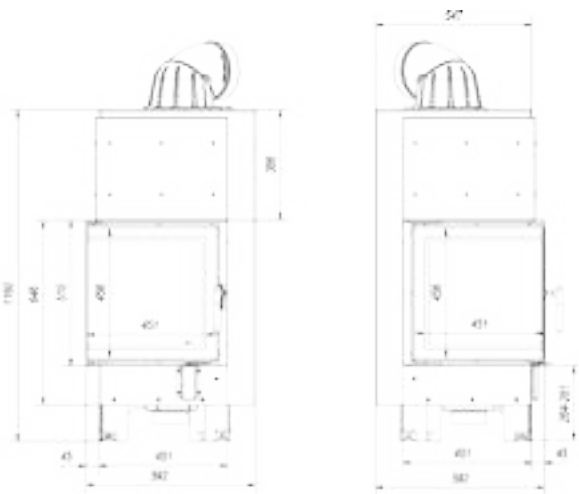
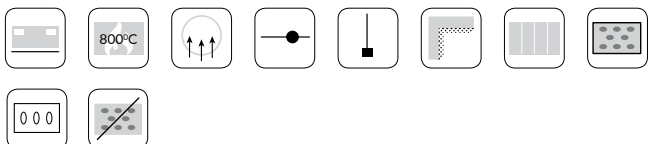

MBN/L/BS



MBN/L/BS



MBN/P/BS/SG



MBN/L/BS/SG



MBN L

## MBN/680



MBN/680/L/BS



≥ 700 cm<sup>2</sup>

≥ 500 cm<sup>2</sup>



kW

10

<kW<

5-12



~81%



200

CO

0,10%

PM

30



261



159



402x626

EEl

108,50

Wyposażenie/Equipment/Ausstattung/Оборудование/  
Vybavení/Equipement/Εξοπλισμός/Attrezzatura/Equipamiento:



MBN/680/P/BS

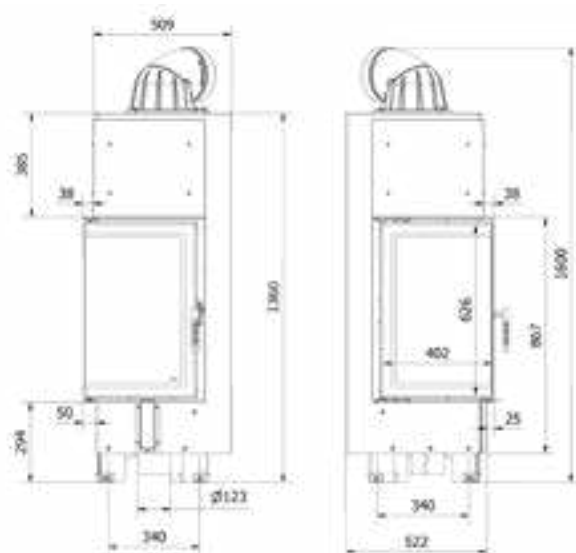

MBN/680/L/BS







# NBU



≥ 900 cm<sup>2</sup>

≥ 700 cm<sup>2</sup>



11



4,5-14



~83%



200



0,09%



17



180



299



491x389



109,30

Wyposażenie/Equipment/Ausstattung/Оборудование/  
 Vybavení/Equipement/Εξοπλισμός/Attrezzatura/Equipamiento:

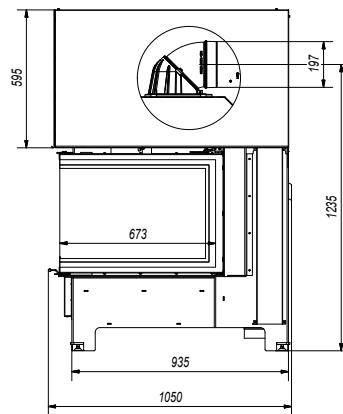
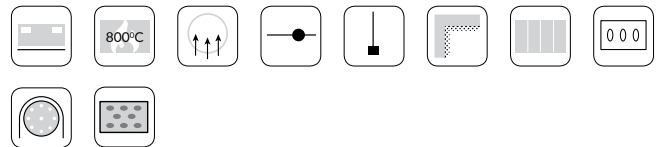

NBU/500/700

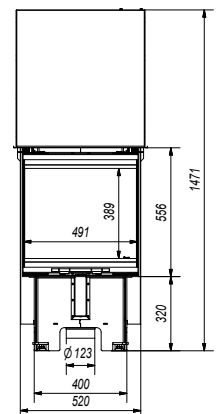

# NBC 7



≥ 700 cm<sup>2</sup>

≥ 500 cm<sup>2</sup>



# NBC 8



≥ 700 cm<sup>2</sup>

≥ 500 cm<sup>2</sup>



kW	<kW<			CO
7	3-9	~83%	160	0,10%

PM				EEI
29	199	188	680x339	105,40

Wyposażenie/Equipment/Ausstattung/Оборудование/  
 Vybavení/Equipement/Εξοπλισμός/Attrezzatura/Equipamiento:



kW	<kW<			CO
8	3,5-10	~83%	200	0,09%

PM				EEI
38	198	238	494x464	105,40

Wyposażenie/Equipment/Ausstattung/Оборудование/  
 Vybavení/Equipement/Εξοπλισμός/Attrezzatura/Equipamiento:

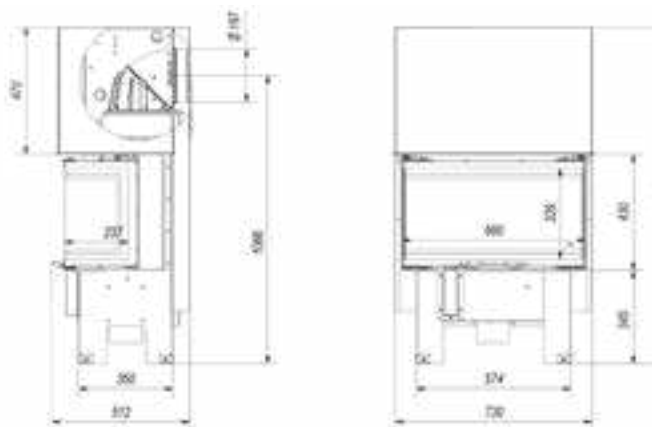

NBC/680/280

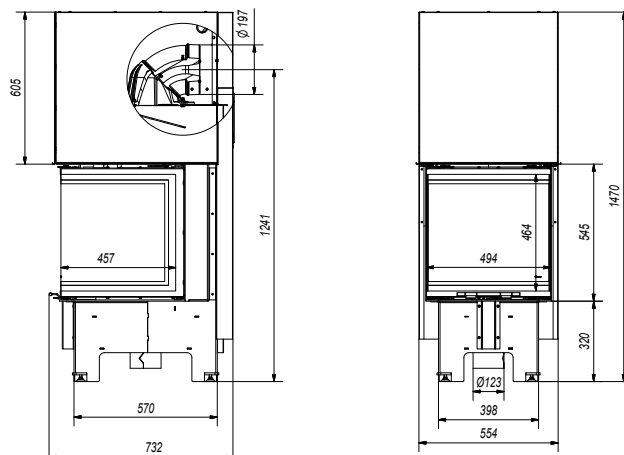

NBC/500/500





# NBC 9



≥ 700 cm<sup>2</sup>

≥ 500 cm<sup>2</sup>



# NBC 10



≥ 900 cm<sup>2</sup>

≥ 700 cm<sup>2</sup>



kW	<kW<			CO
9	4-11	~84%	200	0,09%
PM				EEl
22	192	235	594x464	105,40

kW	<kW<			CO
10	5-13	~83%	200	0,06%
PM				EEl
27	191	275	794x464	106,71

Wyposażenie/Equipment/Ausstattung/Оборудование/  
 Vybavení/Equipement/Εξοπλισμός/Attrezzatura/Equipamiento:



Wyposażenie/Equipment/Ausstattung/Оборудование/  
 Vybavení/Equipement/Εξοπλισμός/Attrezzatura/Equipamiento:

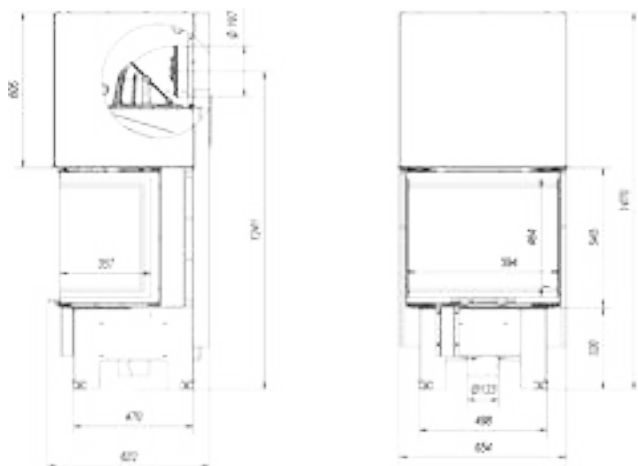

NBC/600/400

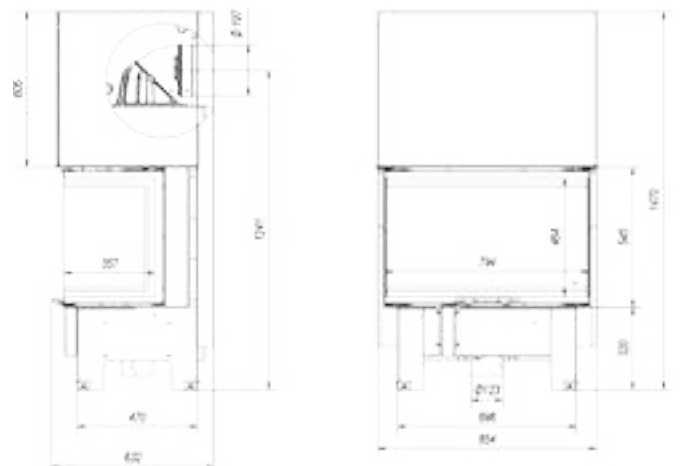

NBC/800/400

# LUCY 12



≥ 900 cm<sup>2</sup>

≥ 700 cm<sup>2</sup>



kW	<kW<	~80%	200	CO
12	5-15			0,10%

PM	°C	kg	610x460	EEI
15	270	166		105,40

Wyposażenie/Equipment/Ausstattung/Оборудование/  
 Vybavení/Equipement/Εξοπλισμός/Attrezzatura/Equipamiento:

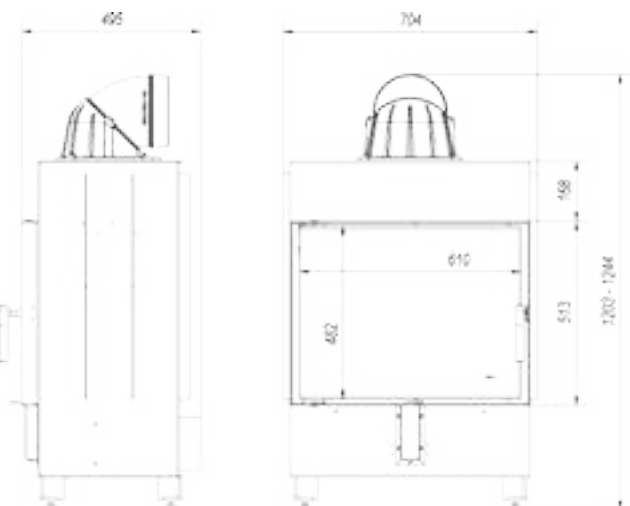
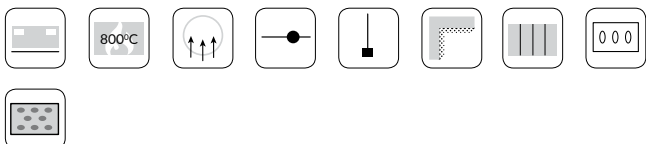

LUCY/12



LUCY/12/L/BS



LUCY/12/P/BS



LUCY/12/T



LUCY SLIM P

## LUCY 12 SLIM



≥ 700 cm<sup>2</sup>

≥ 500 cm<sup>2</sup>



8



3-10



~83%



160



0,09%



9



180



155



610x482



109,30

Wyposażenie/Equipment/Ausstattung/Оборудование/  
 Vybavení/Equipement/Εξοπλισμός/Attrezzatura/Equipamiento:

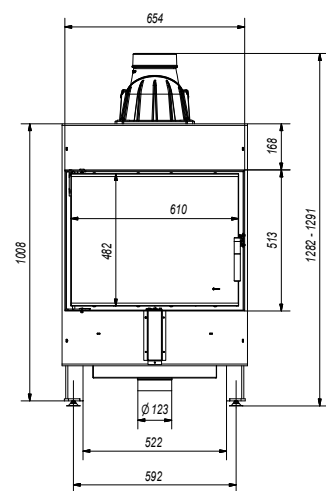
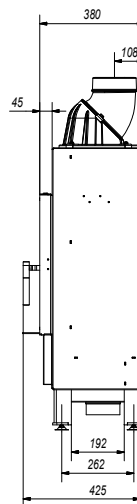

LUCY/12/SLIM



LUCY/12/SLIM/L/BS



LUCY/12/SLIM/P/BS

# LUCY 14



≥ 900 cm<sup>2</sup>

≥ 700 cm<sup>2</sup>



<b>kW</b>	<b>&lt;kW&lt;</b>			<b>CO</b>
14	6-17	~81%	200	0,10%

<b>PM</b>				<b>EEl</b>
18	265	182	760x460	106,71

Wyposażenie/Equipment/Ausstattung/Оборудование/  
 Vybavení/Equipement/Εξοπλισμός/Attrezzatura/Equipamiento:

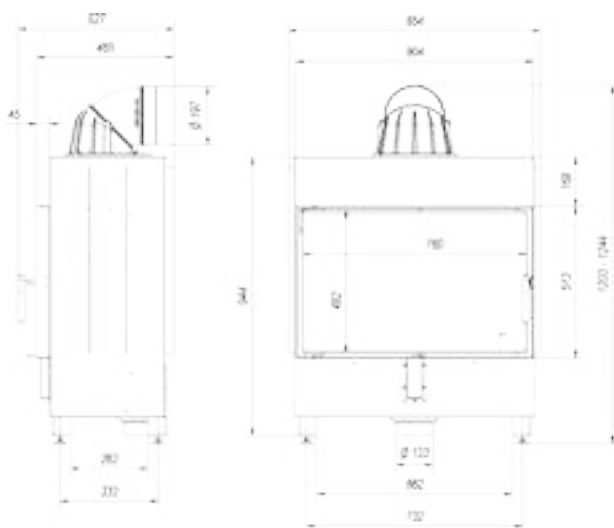
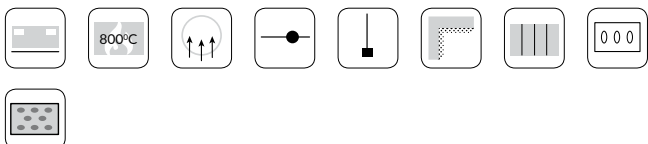

LUCY/14



LUCY/14/L/BS



LUCY/14/P/BS



LUCY/14/T





LUCY 14

# LUCY 14 SLIM



≥ 700 cm<sup>2</sup>

≥ 500 cm<sup>2</sup>



10



4-12



~85%



160



0,09%



19



172



180



760x480



111,90

Wyposażenie/Equipment/Ausstattung/Оборудование/  
 Vybavení/Equipement/Εξοπλισμός/Attrezzatura/Equipamiento:



LUCY 14/SLIM/L/BS



LUCY 14/SLIM/P/BS

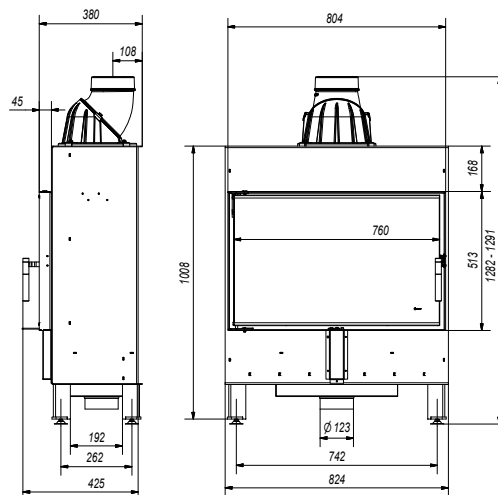

LUCY 14/SLIM

# LUCY 15



≥ 700 cm<sup>2</sup>

≥ 500 cm<sup>2</sup>



kW	<kW<			CO
15	6,5-18,5	~81%	200	0,10%

PM				EEl
19	263	205	760x590	106,71

Wyposażenie/Equipment/Ausstattung/Оборудование/  
 Vybavení/Equipement/Εξοπλισμός/Attrezzatura/Equipamiento:

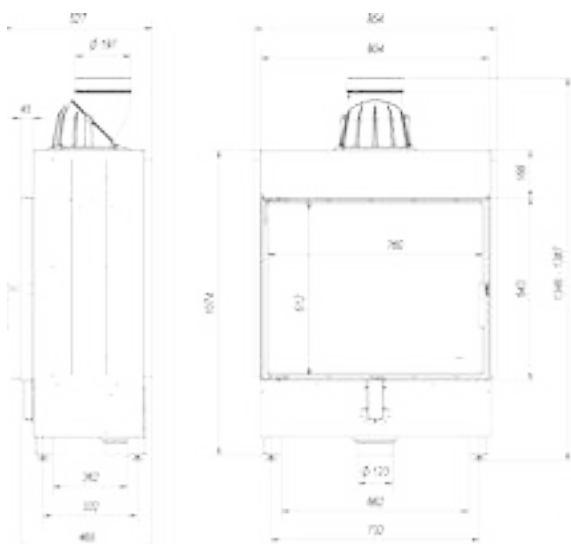
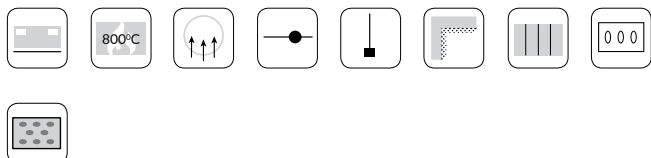

LUCY/15





LUCY 15

# LUCY 16



≥ 900 cm<sup>2</sup>

≥ 700 cm<sup>2</sup>



<b>kW</b> 16	<b>&lt;kW&lt;</b> 7-20	<b>~81%</b>	<b>200</b>	<b>CO</b> 0,09%
<b>PM</b> 20	<b>260</b>	<b>213</b>	<b>905x411</b>	<b>EEl</b> 106,71

Wyposażenie/Equipment/Ausstattung/Оборудование/  
Vybavení/Equipement/Εξοπλισμός/Attrezzatura/Equipamiento:

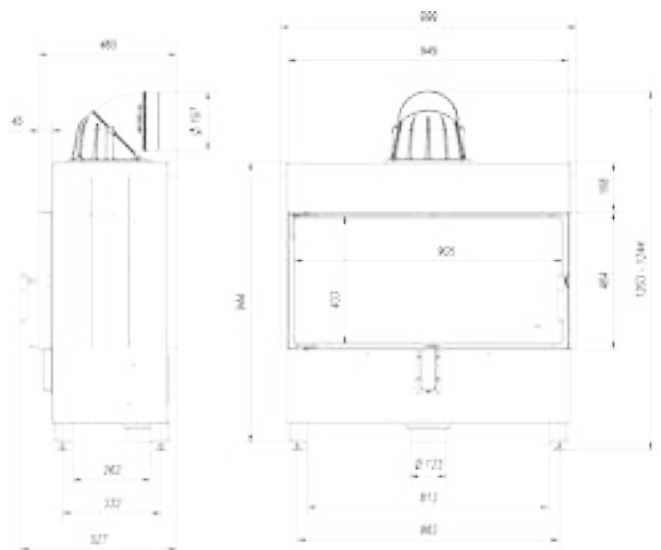
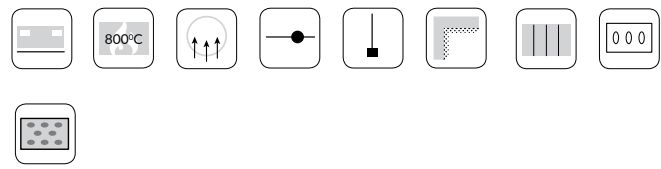

LUCY/16

# NADIA 8



≥ 700 cm<sup>2</sup>

≥ 500 cm<sup>2</sup>



kW

7

<kW<

3-9



~80%



200

CO

0,10%

PM

38

°C

245

kg

106



410x482

EEl

105,40

Wyposażenie/Equipment/Ausstattung/Оборудование/  
 Vybavení/Equipment/Εξοπλισμός/Attrezzatura/Equipamiento:



Dodatkové opcje/Additional options/Zusätzliche Optionen/  
 /Дополнительные опции/Dodatečné vybavení/Options supplémentaires/  
 Επιπλέον επιλογές/Opzioni aggiuntive/ Opciones adicionales:

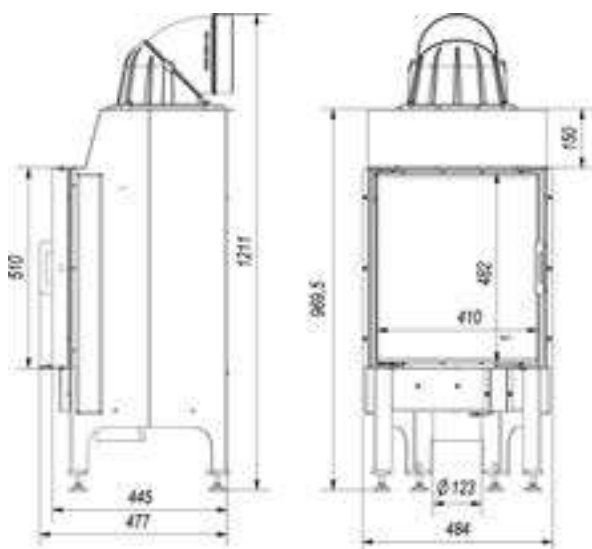

NADIA/8



# NADIA 9



≥ 700 cm<sup>2</sup>

≥ 500 cm<sup>2</sup>



kW

9

<kW<

5-11



~80%



200

CO

0,10%

PM

35

°C

251

kg

128

407x647

EEl

105,40

Wyposażenie/Equipment/Ausstattung/Оборудование/  
Vybavení/Equipement/Εξοπλισμός/Attrezzatura/Equipamiento:

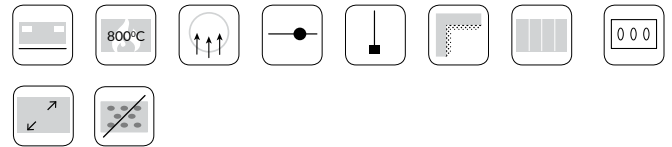

Dodatkové opcje/Additional options/Zusätzliche Optionen/  
Дополнительные опции/Dodatečné vybavení/Options supplémentaires/  
Επιπλέον επιλογές/Opcioni aggiuntive/Opciones adicionales:

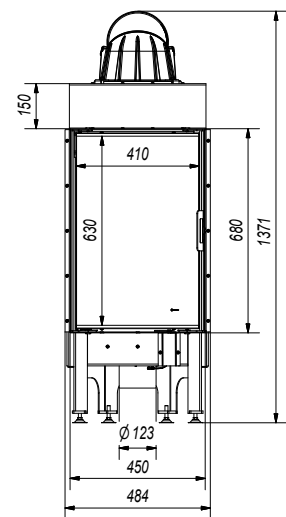
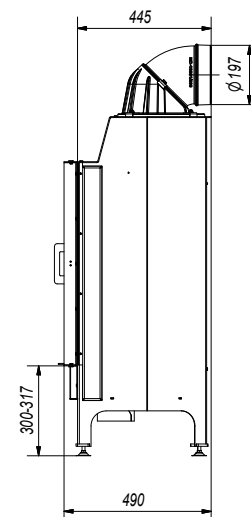

# NADIA 10



≥ 900 cm<sup>2</sup>

≥ 700 cm<sup>2</sup>



<b>kW</b>	<b>&lt;kW&lt;</b>			<b>CO</b>
10	5-12,5	~80%	200	0,10%

<b>PM</b>				<b>EEl</b>
32	255	128	610x460	105,40

Wyposażenie/Equipment/Ausstattung/Оборудование/  
Vybavení/Equipement/Εξοπλισμός/Attrezzatura/Equipamiento:

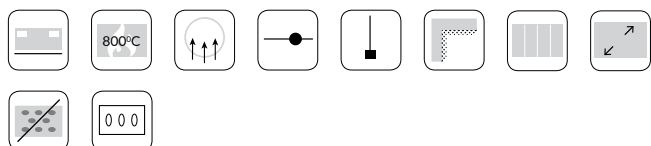

Dodatkové opcje/Additional options/Zusätzliche Optionen/  
Дополнительные опции/Dodatečné vybavení/Options supplémentaires/  
Επιπλέον επιλογές/Opzioni aggiuntive/Opciones adicionales:

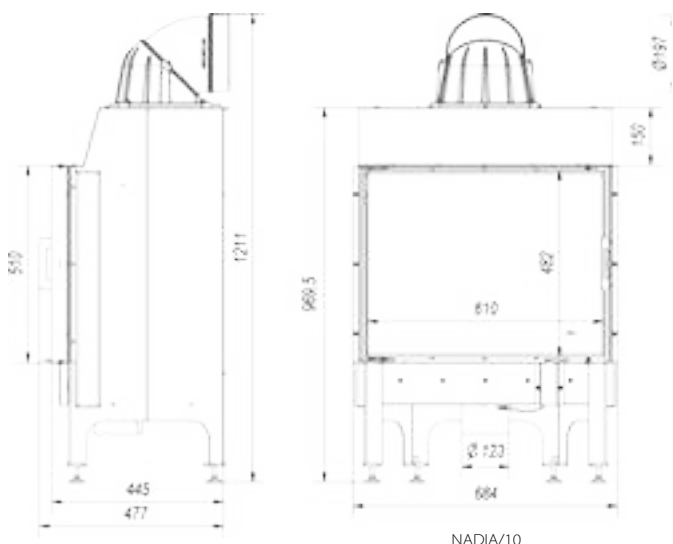
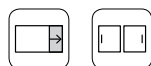

NADIA/10



NADIA/10/G



NADIA 10

# NADIA 12



≥ 900 cm<sup>2</sup>

≥ 700 cm<sup>2</sup>



<b>kW</b> 12	<b>&lt;kW&lt;</b> 8-16	 ~80%	 200	<b>CO</b> 0,08%
<b>PM</b> 36	 245	 149	 757x460	<b>EEl</b> 105,40

Wyposażenie/Equipment/Ausstattung/Оборудование/  
Vybavení/Equipement/Εξοπλισμός/Attrezzatura/Equipamiento:

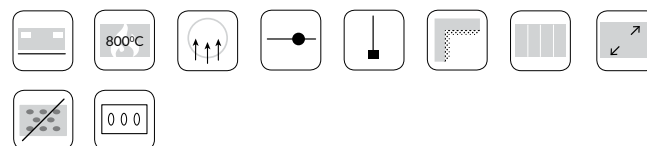

Dodatkové opcje/Additional options/Zusätzliche Optionen:  
/Дополнительные опции/Dodatečné vybavení/Options supplémentaires/Επιπλέον επιλογές/Opzioni aggiuntive/ Opciones adicionales:

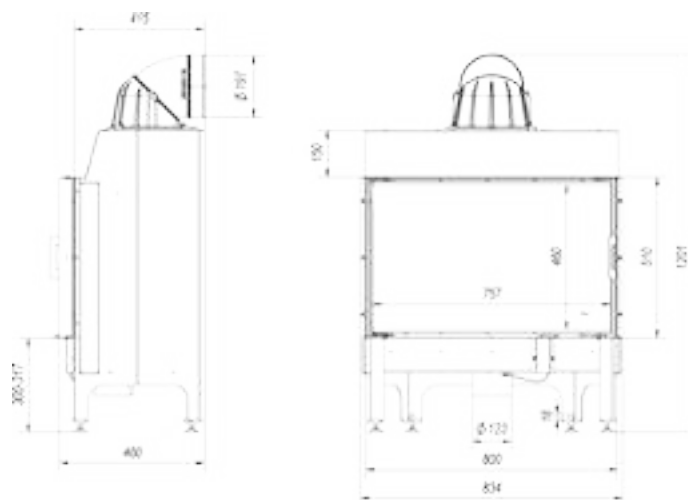

NADIA/12



NADIA/12/G

# NADIA 13



≥ 900 cm<sup>2</sup>

≥ 700 cm<sup>2</sup>



kW	<kW<			CO
13	6-16,5	~81%	200	0,08%

PM				EEl
37	240	178	760x612	106,71

Wyposażenie/Equipment/Ausstattung/Оборудование/  
 Vybavení/Equipement/Εξοπλισμός/Attrezzatura/Equipamiento:

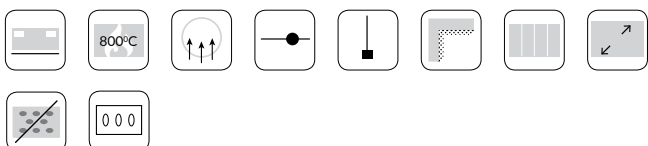

Dodatkové opcie/Additional options/Zusätzliche Optionen/  
 /Дополнительные опции/Dodatečné vybavení/Options supplémentaires/  
 Επιπλέον επιλογές/Opcioni aggiuntive/Opciones adicionales:

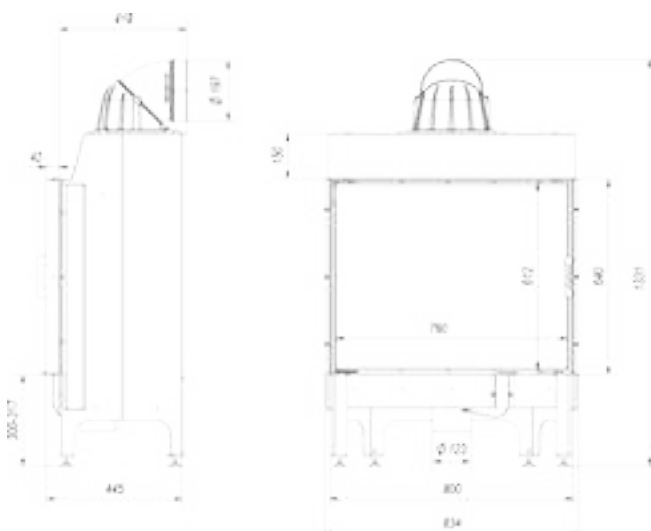

NADIA/13



NADIA/13/G





NADIA 13

# NADIA 14



≥ 900 cm<sup>2</sup>

≥ 700 cm<sup>2</sup>



<b>kW</b> 14	<b>&lt;kW&lt;</b> 6,5-17	<b>Flame</b> ~80%	<b>Flow</b> 200	<b>CO</b> 0,09%
<b>PM</b> 37	<b>Temp</b> 245	<b>Weight</b> 173	<b>Dimensions</b> 902x411	<b>EEl</b> 105,40

Wyposażenie/Equipment/Ausstattung/Оборудование/  
Vybavení/Equipement/Εξοπλισμός/Attrezzatura/Equipamiento:

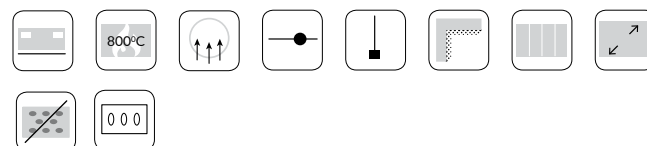

Dodatkové opcje/Additional options/Zusätzliche Optionen/  
Дополнительные опции/Dodatečné vybavení/Options supplémentaires/  
Επιπλέον επιλογές/Opzioni aggiuntive/ Opciones adicionales:

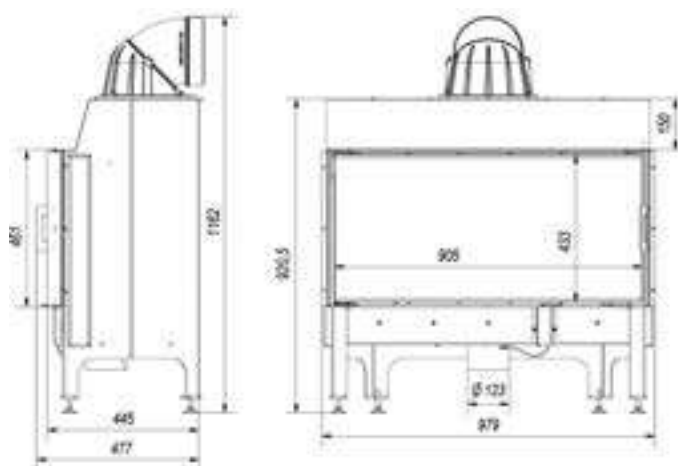

NADIA/14



NADIA/14/G



NADIA/14/L/BS/G



NADIA/14/P/BS/G

# BLANKA 8



≥ 700 cm<sup>2</sup>

≥ 500 cm<sup>2</sup>



<b>kW</b> 8	<b>&lt;kW&lt;</b> 7,5-11	 ~78%	 160	<b>CO</b> 0,10%
<b>PM</b> 36	 285	 120	 344x406	<b>EEl</b> 102,79

Wyposażenie/Equipment/Ausstattung/Оборудование/  
Vybavení/Equipement/Εξοπλισμός/Attrezzatura/Equipamiento:

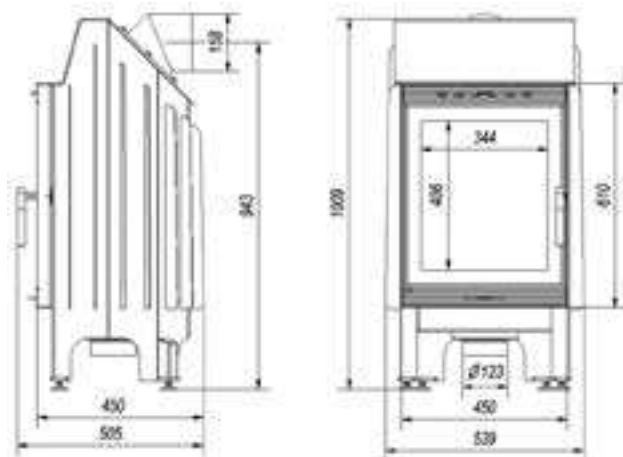
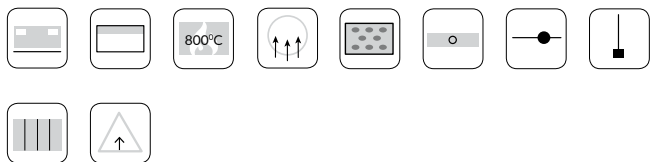

BLANKA/PF



BLANKA/L/BS



BLANKA/P/BS



BLANKA/LP/BS



BLANKA BETON

# BLANKA 12



≥ 900 cm<sup>2</sup>  
≥ 700 cm<sup>2</sup>



<b>kW</b> 11	<b>&lt;kW&lt;</b> 7,1-14,5	 ~78%	 200	<b>CO</b> 0,09%
<b>PM</b> 40	 280	 154	 570x372	<b>EEI</b> 102,79

Wyposażenie/Equipment/Ausstattung/Оборудование/  
Vybavení/Equipement/Εξοπλισμός/Attrezzatura/Equipamiento:

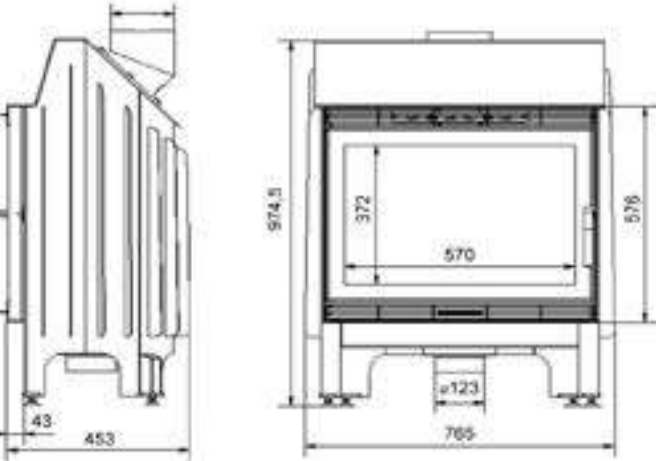
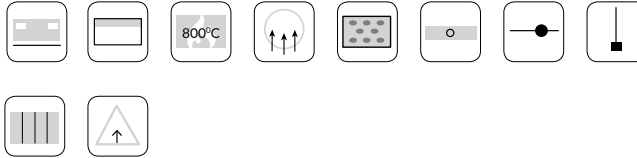

BLANKA/670/570



BLANKA/670/570/L/BS



BLANKA/670/570/P/BS



BLANKA/670/570/LP/BS

# BLANKA 14



≥ 1000 cm<sup>2</sup>

≥ 800 cm<sup>2</sup>



<b>kW</b>	<b>&lt;kW&lt;</b>			<b>CO</b>
16	7,5-21,5	~83%	200	0,10%

<b>PM</b>				<b>EEl</b>
40	290	195	824x345	109,32

Wyposażenie/Equipment/Ausstattung/Оборудование/  
 Vybavení/Equipement/Εξοπλισμός/Attrezzatura/Equipamiento:

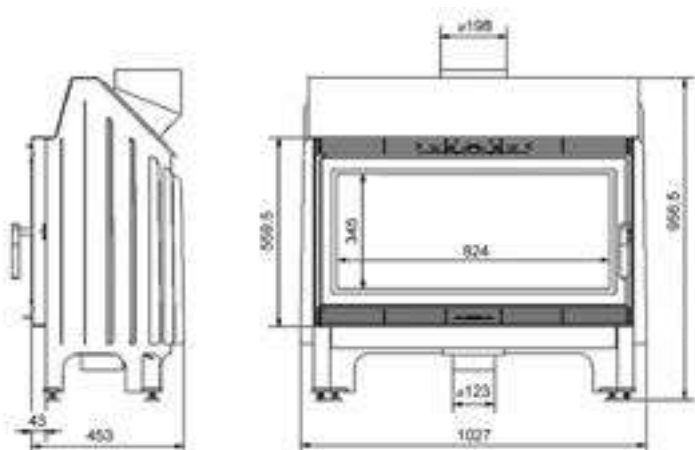
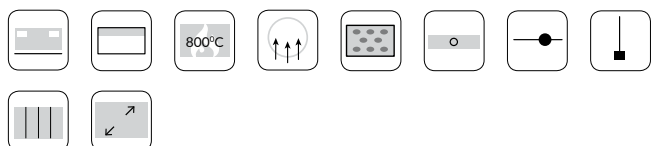

BLANKA/910





BLANKA 910

## ZIBI



≥ 900 cm<sup>2</sup>

≥ 700 cm<sup>2</sup>



kW

11

<kW<

4,5-14

~80%

180

CO

0,10%

PM

38

290

150

552x344

EEl

105,40

Wyposażenie/Equipment/Ausstattung/Оборудование/  
 Vybavení/Equipement/Εξοπλισμός/Attrezzatura/Equipamiento:

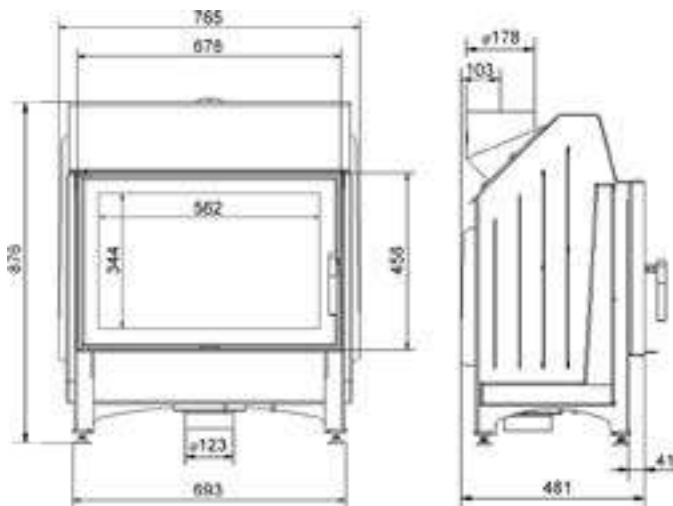
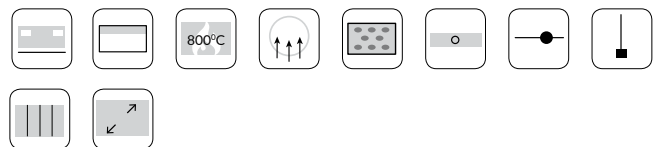

ZIBI/PF



ZIBI/L/BS



ZIBI/P/BS



ZIBI/DECO



ZIBI/L/BS/DECO



ZIBI/P/BS/DECO



ZIBI/G

# BASIA



≥ 900 cm<sup>2</sup>

≥ 700 cm<sup>2</sup>

**A**

kW	<kW<			CO
12	6,8-17	~70%	200	0,15%
PM				EEI
67	350	133	598x354	92,35

Wyposażenie/Equipment/Ausstattung/Оборудование/  
 Vybavení/Equipement/Εξοπλισμός/Attrezzatura/Equipamiento:

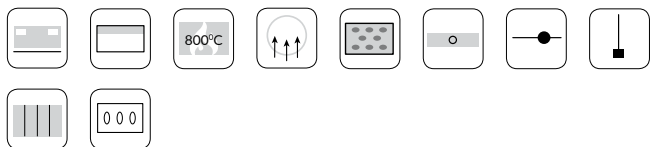

Dodatkowe opcje/Additional options/Zusätzliche Optionen:  
 /Дополнительные опции/Dodatečné vybavení/Options supplémentaires/  
 Επιπλέον επιλογές/Opcioni aggiuntive/Opciones adicionales:

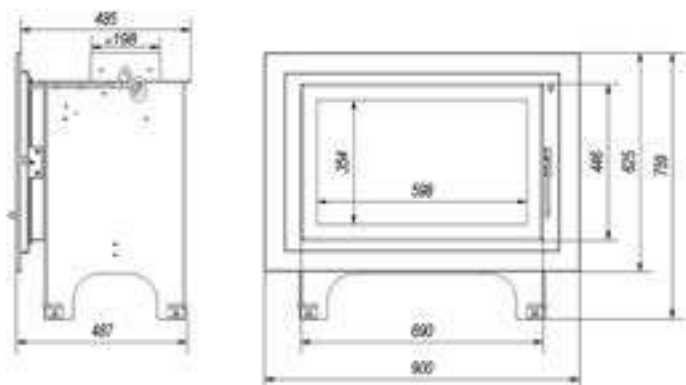

BASIA/PF





BASIA

## MILA



≥ 1000 cm<sup>2</sup>

≥ 800 cm<sup>2</sup>

A

kW	<kW<			CO
16	8-22	~71%	200	0,26%
PM				EEl
21	345,3	187	824x345	93,66

Wyposażenie/Equipment/Ausstattung/Оборудование/  
Vybavení/Équipement/Εξοπλισμός/Attrezzatura/Equipamiento:

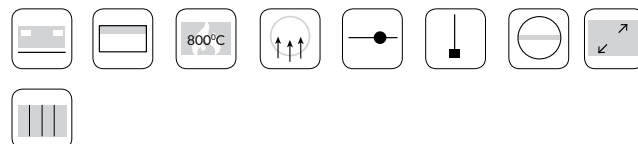

Dodatkowe opcje/Additional options/Zusätzliche Optionen:  
/Дополнительные опции;/Dodatečné vybavení;/Options supplémentaires;/Επιπλέον επιλογές;/Opzioni aggiuntive;/ Opciones adicionales:



MILA/T

MILA/G

MILA/T/G

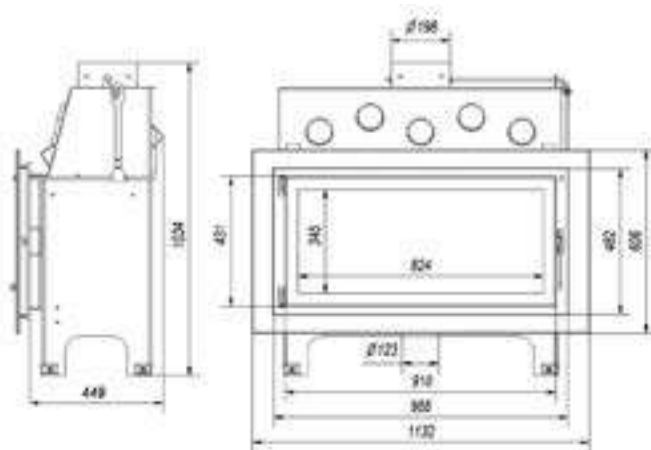

MILA/PF

# SIMPLE S



SIMPLE/S/L/BS



≥ 700 cm<sup>2</sup>

≥ 500 cm<sup>2</sup>



kW	<kW<			CO
7	3,5-8	~80%	150	0,10%
PM				EEl
-	200	91	580x367	110,50

Wyposażenie/Equipment/Ausstattung/Оборудование/  
 Vybavení/Equipement/Εξοπλισμός/Attrezzatura/Equipamiento:

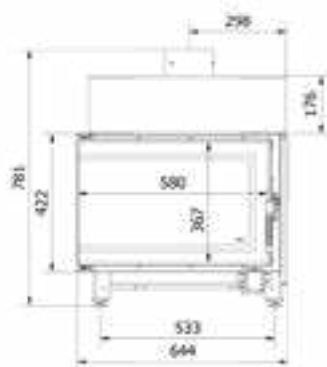

SIMPLE/S/L/BS



SIMPLE/S/P/BS





JAS

# JAS



≥ 700 cm<sup>2</sup>

≥ 500 cm<sup>2</sup>

**A**

kW

7

<kW<

3,3-9,9

~71%

~71%

150

150

CO

0,15%

PM

67

°C

316

kg

82

562x338

562x338

EEI

93,66

Wyposażenie/Equipment/Ausstattung/Оборудование/  
Vybavení/Equipement/Εξοπλισμός/Attrezzatura/Equipamiento:

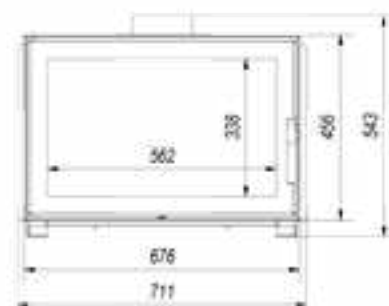

JAS/PF

JAS

# ARKE 70



≥ 700 cm<sup>2</sup>

≥ 500 cm<sup>2</sup>



# ARKE 75



≥ 700 cm<sup>2</sup>

≥ 500 cm<sup>2</sup>



kW	<kW<			CO
8	3,5-10	~84%	150	0,09%

PM				EEl
14	165	110	617x321	110,62

kW	<kW<			CO
8	4-11	~83%	150	0,10%

PM				EEl
15	171	115	677x373	109,32

Wyposażenie/Equipment/Ausstattung/Оборудование/  
 Vybavení/Equipement/Εξοπλισμός/Attrezzatura/Equipamiento:



Wyposażenie/Equipment/Ausstattung/Оборудование/  
 Vybavení/Equipement/Εξοπλισμός/Attrezzatura/Equipamiento:

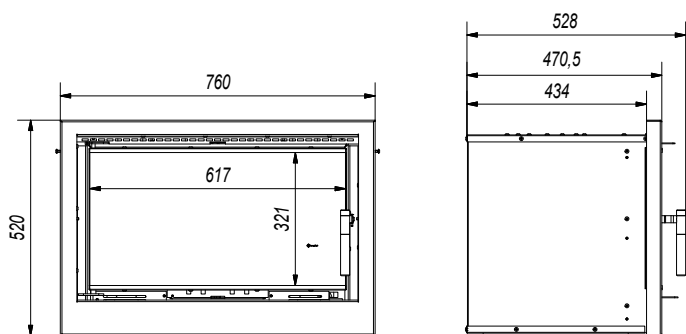

KASETA/ARKE/70

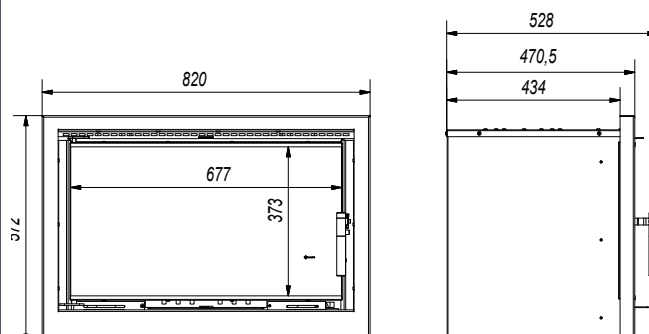

KASETA/ARKE/75

# ARKE 80



≥ 900 cm<sup>2</sup>

≥ 700 cm<sup>2</sup>



# ARKE 95



≥ 900 cm<sup>2</sup>

≥ 700 cm<sup>2</sup>



kW	<kW<			CO
12	6-16	~75%	200	0,10%

PM				EEl
34	320	132	707x415	98,88

Wyposażenie/Equipment/Ausstattung/Оборудование/  
 Vybavení/Equipement/Εξοπλισμός/Attrezzatura/Equipamiento:



kW	<kW<			CO
14	6-16,5	~83%	200	0,10%

PM				EEl
37	195	154	887x421	109,32

Wyposażenie/Equipment/Ausstattung/Оборудование/  
 Vybavení/Equipement/Εξοπλισμός/Attrezzatura/Equipamiento:

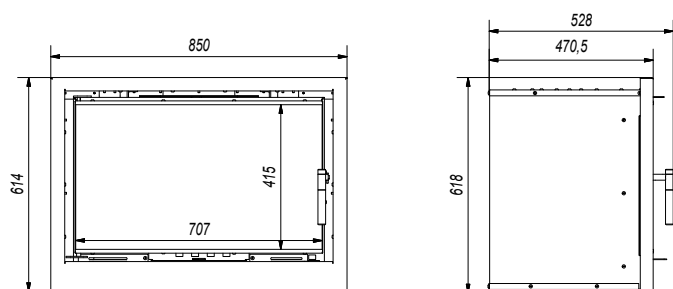

KASETA/ARKE/80

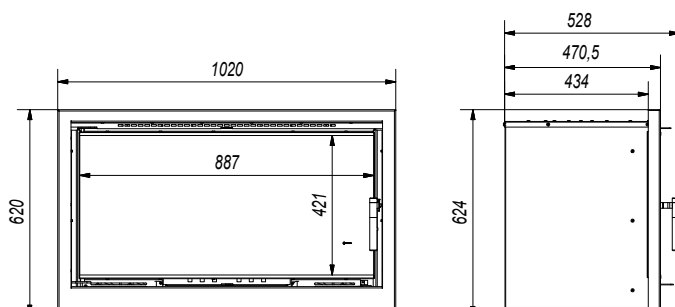

KASETA/ARKE/95

# VN 480



VNL/480/480  
VNP/480/480



≥ 700 cm<sup>2</sup>

≥ 500 cm<sup>2</sup>



# VN 610



VNL/610/430  
VNP/610/430



≥ 700 cm<sup>2</sup>

≥ 500 cm<sup>2</sup>



kW	<kW<			CO
8	3,5-10	~84%	200	0,10%

PM				EEl
33	285	198	452x452	111,01

kW	<kW<			CO
9	3,5-11	~81%	200	0,09%

PM				EEl
23	285	204	582x433	106,71

Wyposażenie/Equipment/Ausstattung/Оборудование/  
Vybavení/Equipement/Εξοπλισμός/Attrezzatura/Equipamiento:

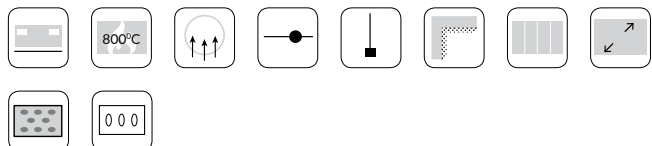

Wyposażenie/Equipment/Ausstattung/Оборудование/  
Vybavení/Equipement/Εξοπλισμός/Attrezzatura/Equipamiento:

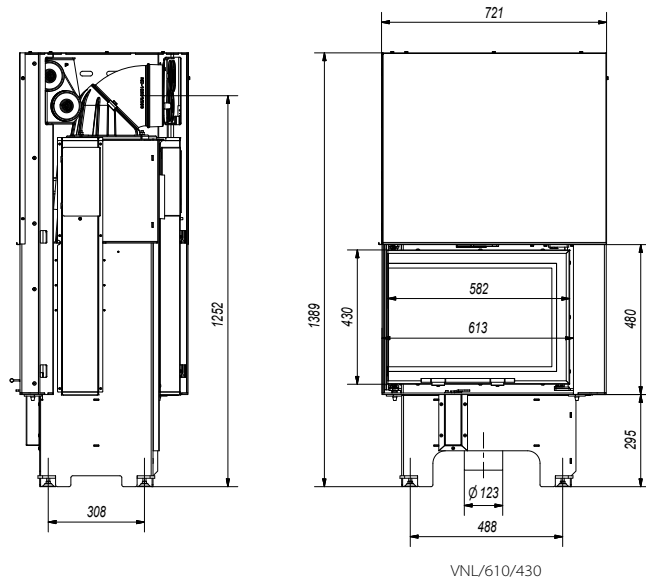
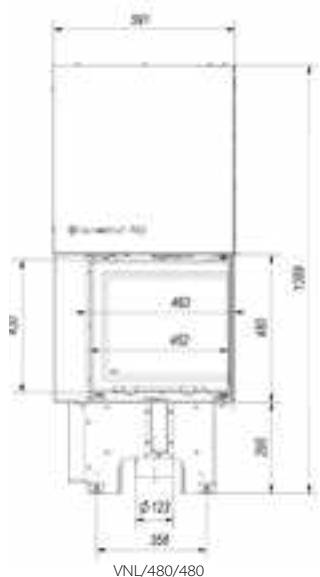
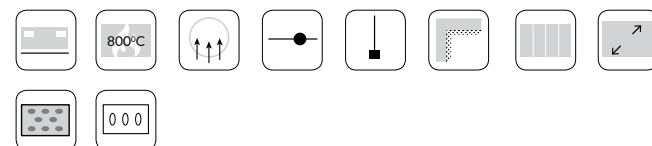

# VN 700



VNL/700/480  
VNP/700/480



≥ 900 cm<sup>2</sup>

≥ 700 cm<sup>2</sup>



# VN 810



VNL/810/410  
VNP/810/410



≥ 900 cm<sup>2</sup>

≥ 700 cm<sup>2</sup>



<b>kW</b>	<b>&lt;kW&lt;</b>			<b>CO</b>
12	5-15	~82%	200	0,1%

<b>PM</b>				<b>EEl</b>
27	240	250	627x490	108

<b>kW</b>	<b>&lt;kW&lt;</b>			<b>CO</b>
14	6-17	~82%	200	0,09%

<b>PM</b>				<b>EEl</b>
13	245	261	782x490	108

Wyposażenie/Equipment/Ausstattung/Оборудование/  
Vybavení/Equipement/Εξοπλισμός/Attrezzatura/Equipamiento:

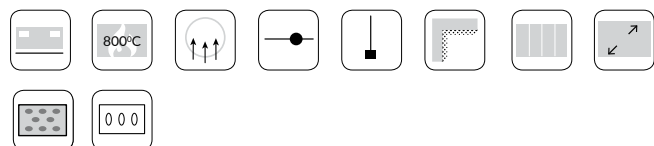



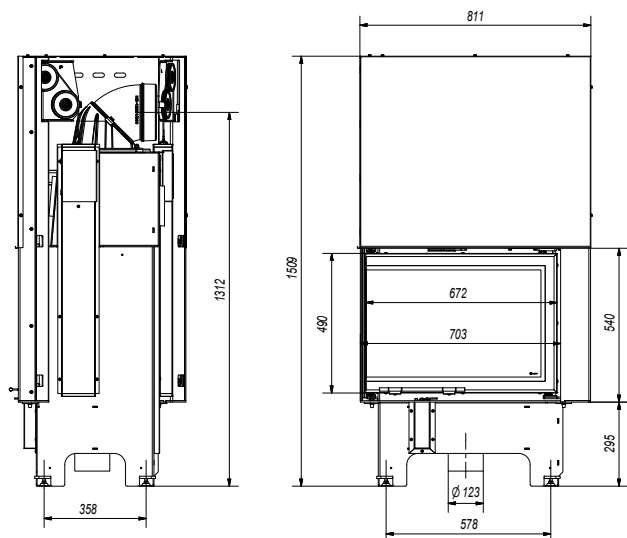
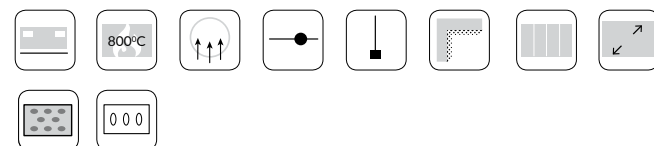



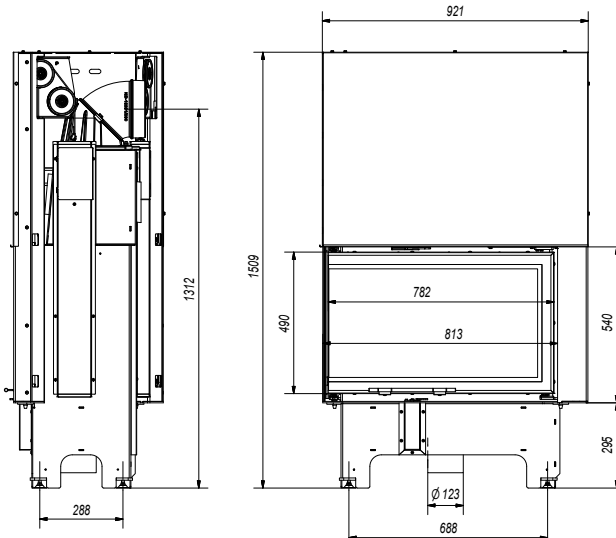





Wyposażenie/Equipment/Ausstattung/Оборудование/  
Vybavení/Equipement/Εξοπλισμός/Attrezzatura/Equipamiento:



VNL/700/480



VNL/810/410

														
MBM	10	4,5 - 12,5	81	0,1	28	106,71	235	200	A	✓	✓	✓	161	50
MBZ	13	6.0 - 16.0	81	0,09	27	106,71	235	200	A	✓	✓	✓	185	50
MBO	15	7.0 - 19.0	83	0,09	30	109,32	240	200	A+	✓	✓	✓	214	50
MBA	17	8.0 - 21.0	80	0,09	35	105,40	250	200	A	✓	✓	✓	222	50
MBN	8	4.0 - 11.0	80	0,1	21	105,40	255	200	A	✓	✓	✓	159	30
MBN 680	10	5.0 - 12.0	81	0,1	30	108,50	261	200	A+	✓	✓	✓	159	30
MB 100 G	14	6.0 - 17.0	82	0,1	27	108,01	220	200	A	✓	✓	✓	327	50
MB 120 G	22	10.0 - 27.0	80	0,1	11	105,40	240	200	A	✓	✓	✓	396	50
NBC 7	7	3.0 - 9.0	83	0,1	29	105,40	199	160	A	✓	✓	✓	188	40
NBC 8	8	3.5 - 10.0	83	0,09	38	105,40	198	200	A	✓	✓	✓	238	40
NBC 9	9	4.0 - 11.0	84	0,09	22	105,40	192	200	A	✓	✓	✓	235	30
NBC 10	10	5.0 - 13.0	83	0,06	27	106,71	191	200	A	✓	✓	✓	275	30
NBU 11	11	4,5 - 14.0	83	0,09	17	109,30	180	200	A+	✓	✓	✓	299	50
LUCY/12	12	5.0 - 15.0	80	0,1	15	105,40	270	200	A	✓	✓	✓	166	35
LUCY/12/SLIM	8	3.0 - 10.0	83	0,09	9	109,30	180	160	A+	✓	✓	✓	155	35
LUCY/14	14	6.0 - 17.0	81	0,1	18	106,71	265	200	A	✓	✓	✓	182	40
LUCY/14/SLIM	10	4.0 - 12.0	85	0,09	19	111,90	172	160	A+	✓	✓	✓	180	40
LUCY/15	15	6.5 - 18.5	81	0,1	19	106,71	263	200	A	✓	✓	✓	205	40
LUCY/16	16	7.0 - 20.0	81	0,09	20	106,71	260	200	A	✓	✓	✓	213	50
NADIA/8	7	3.0 - 9.0	80	0,1	38	105,40	245	200	A	✓	✓	✓	106	30
NADIA/9	9	5.0 - 11.0	80	0,1	35	105,40	251	200	A	✓	✓	✓	128	32
NADIA/10	10	5.0 - 12.5	80	0,1	32	105,40	255	200	A	✓	✓	✓	128	35
NADIA/12	12	8.0 - 16.0	80	0,08	36	105,40	245	200	A	✓	✓	✓	149	40
NADIA/13	13	6.0 - 16.5	81	0,08	37	106,71	240	200	A	✓	✓	✓	178	40
NADIA/14	14	6.5 - 17.0	80	0,09	37	105,40	245	200	A	✓	✓	✓	173	50
BLANKA/8	8	7.5 - 11.0	78	0,1	36	102,79	285	160	A	✓		✓	120	30
BLANKA 670/570	11	7.1 - 14.5	78	0,09	40	102,79	280	180	A	✓		✓	154	50
BLANKA 910	16	7.5 - 21.5	83	0,1	40	109,32	290	200	A+	✓		✓	195	50
MILA	16	8.0 - 22.0	71	0,26	21	93,66	345,3	200	A			✓	187	70
BASIA	12	6.8 - 17.0	70	0,15	67	92,35	350	200	A			✓	133	50
JAS/PF	7	3.3 - 9.9	71	0,15	67	93,66	316	150	A			✓	82	40
KASETA/ARKE/70	8	3,5 - 10.0	84	0,09	14	110,62	165	150	A+	✓		✓	110	30
KASETA/ARKE/75	8	4.0 - 11.0	83	0,09	15	109,32	165	150	A+	✓		✓	110	30
KASETA/ARKE/80	12	6.0 - 16.0	75	0,1	34	98,88	320	200	A	✓		✓	132	35
KASETA/ARKE/95	14	6.0 - 16.5	83	0,1	17	109,32	325	200	A+	✓		✓	154	50
ZIBI/PF	11	4.5 - 14.0	80	0,1	38	105,4	290	180	A	✓	✓	✓	150	40
VN 610/430	9	3.5 - 11.0	81	0,09	23	106,71	285	200	A	✓		✓	204	40
VN 480/480	8	3.5 - 10.0	84	0,1	33	111,01	285	200	A+	✓		✓	198	30
VN 700/480	12	5.0 - 15.0	82	0,1	27	108	240	200	A+	✓		✓	250	40
VN 810/410	14	6.0 - 17.0	82	0,09	13	108	245	200	A+	✓		✓	261	40
SIMPLE S	7	3,5 - 8.0	80	0,10	-	110,5	200	150	A+		✓	✓	91	40

	$\geq m^2 I$	$\geq m^2 I$																
535x413	$\geq 700$	$\geq 500$	✓	✓		✓		✓	✓		✓		✓		✓	✓	✓	✓
584x474	$\geq 900$	$\geq 700$	✓	✓		✓		✓	✓		✓		✓		✓	✓	✓	✓
686x476	$\geq 900$	$\geq 700$	✓	✓		✓		✓	✓		✓		✓		✓	✓	✓	✓
686x536	$\geq 1000$	$\geq 800$	✓	✓		✓		✓	✓		✓		✓		✓	✓	✓	✓
457x474	$\geq 700$	$\geq 500$		✓		✓		✓	✓		✓		✓		✓	✓	✓	✓
402x626	$\geq 700$	$\geq 500$		✓	✓						✓		✓		✓	✓	✓	✓
955x314	$\geq 900$	$\geq 700$	✓					✓	✓		✓		✓		✓	✓	✓	✓
1155x384	$\geq 1000$	$\geq 800$	✓					✓	✓		✓		✓		✓	✓	✓	✓
680x339	$\geq 700$	$\geq 500$								✓	✓		✓		✓	✓	✓	✓
494x464	$\geq 700$	$\geq 500$								✓	✓		✓		✓	✓	✓	✓
594x464	$\geq 700$	$\geq 500$								✓	✓		✓		✓	✓	✓	✓
794x464	$\geq 700$	$\geq 500$								✓	✓		✓		✓	✓	✓	✓
483x509	$\geq 900$	$\geq 700$								✓	✓		✓		✓	✓	✓	✓
610x460	$\geq 900$	$\geq 700$	✓	✓	✓	✓	✓				✓	✓			✓	✓	✓	✓
610x482	$\geq 700$	$\geq 500$	✓			✓					✓	✓			✓	✓	✓	✓
760x460	$\geq 900$	$\geq 700$	✓	✓	✓	✓	✓				✓	✓			✓	✓	✓	✓
760x480	$\geq 700$	$\geq 500$	✓			✓					✓	✓			✓	✓	✓	✓
760x590	$\geq 900$	$\geq 700$	✓			✓	✓				✓	✓			✓	✓	✓	✓
905x411	$\geq 1000$	$\geq 800$	✓			✓	✓				✓	✓			✓	✓	✓	✓
410x482	$\geq 700$	$\geq 500$	✓			✓	✓				✓		✓	✓	✓	✓	✓	✓
407x647	$\geq 700$	$\geq 500$	✓			✓					✓		✓		✓	✓	✓	✓
610x460	$\geq 900$	$\geq 700$	✓			✓		✓	✓		✓		✓		✓	✓	✓	✓
757x460	$\geq 900$	$\geq 700$	✓			✓		✓	✓		✓		✓		✓	✓	✓	✓
760x612	$\geq 900$	$\geq 700$	✓			✓		✓	✓		✓		✓		✓	✓	✓	✓
902x411	$\geq 900$	$\geq 700$	✓	✓		✓	✓	✓	✓		✓		✓		✓	✓	✓	✓
344x406	$\geq 700$	$\geq 500$	✓	✓		✓	✓				✓	✓		✓	✓			
570x372	$\geq 900$	$\geq 700$	✓	✓	✓	✓	✓				✓	✓			✓			
824x345	$\geq 1000$	$\geq 800$	✓			✓					✓	✓			✓			
824x345	$\geq 1000$	$\geq 800$	✓		✓	✓		✓	✓		✓	✓			✓			
598x354	$\geq 900$	$\geq 700$	✓			✓					✓	✓			✓			
562x338	$\geq 700$	$\geq 500$	✓			✓					✓	✓						
617x321	$\geq 700$	$\geq 500$	✓			✓					✓	✓					✓	✓
677x373	$\geq 700$	$\geq 500$	✓			✓					✓	✓					✓	✓
707x415	$\geq 900$	$\geq 700$	✓			✓					✓	✓					✓	✓
887x421	$\geq 900$	$\geq 700$	✓			✓					✓	✓					✓	✓
552x 344	$\geq 700$	$\geq 900$	✓								✓	✓						
582x430	$\geq 700$	$\geq 500$					✓	✓	✓		✓		✓	✓	✓	✓	✓	✓
452x452	$\geq 700$	$\geq 500$					✓	✓	✓		✓		✓	✓	✓	✓	✓	✓
672x490	$\geq 900$	$\geq 700$					✓	✓	✓		✓		✓	✓	✓	✓	✓	✓
782x490	$\geq 900$	$\geq 700$					✓	✓	✓		✓		✓	✓	✓	✓	✓	✓
580x367	$\geq 700$	$\geq 500$		✓	✓							✓	✓	✓	✓	✓	✓	✓

# FRANEK 10



≥ 700 cm<sup>2</sup>

≥ 500 cm<sup>2</sup>



kW	<kW<			CO
10	5-13	~80%	180	0,10%

PM				EEl
25	265	190	542x430	105,40

Wyposażenie/Equipment/Ausstattung/Оборудование/  
Vybavení/Equipement/Εξοπλισμός/Attrezzatura/Equipamiento:

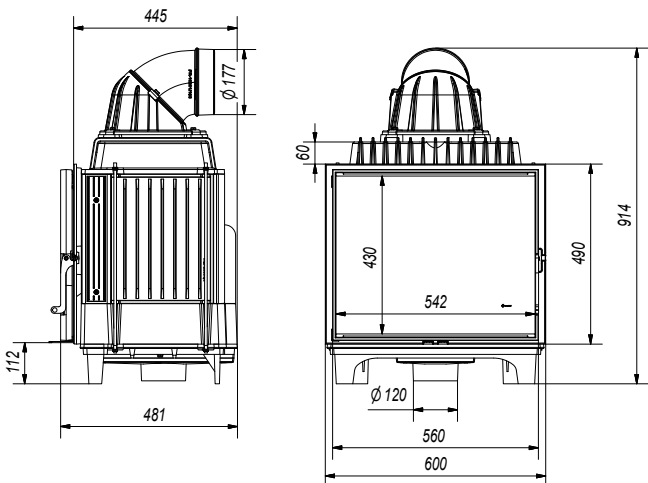
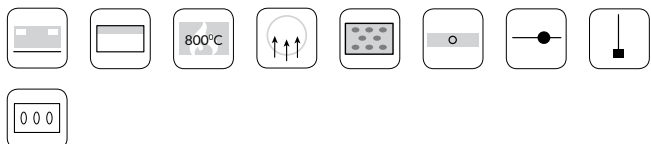

FRANEK/10/PF

# FRANEK 12



≥ 900 cm<sup>2</sup>

≥ 700 cm<sup>2</sup>



kW	<kW<			CO
12	5-14,5	~82%	200	0,09%

PM				EEl
34	215	249	642x480	108,01

Wyposażenie/Equipment/Ausstattung/Оборудование/  
Vybavení/Equipement/Εξοπλισμός/Attrezzatura/Equipamiento:

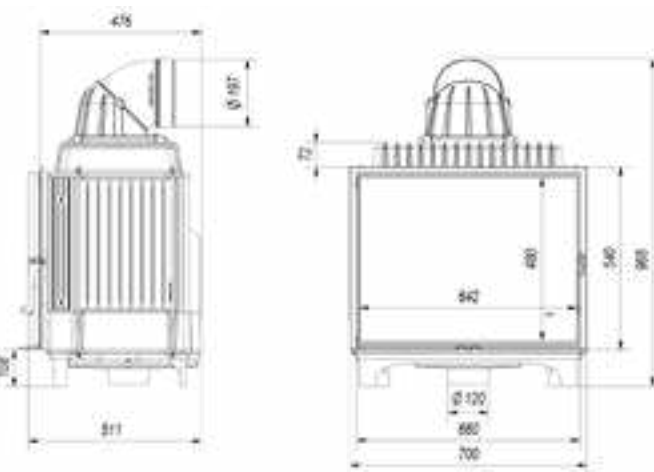
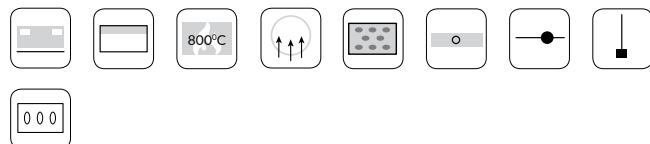

FRANEK/12/PF



# FRANEK 14



≥ 1000 cm<sup>2</sup>

≥ 800 cm<sup>2</sup>



kW	<kW<			CO
14	6-17	~81%	200	0,10%

PM				EEI
19	250	276	742x450	106,71

Wyposażenie/Equipment/Ausstattung/Оборудование/  
 Vybavení/Equipement/Εξοπλισμός/Attrezzatura/Equipamiento:

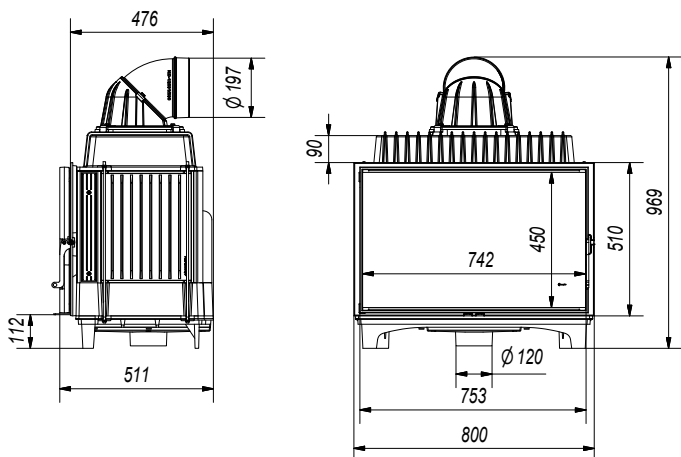
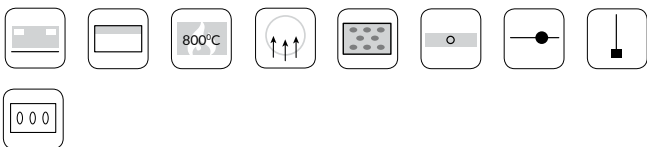

# ZUZIA ECO



≥ 900 cm<sup>2</sup>

≥ 700 cm<sup>2</sup>



<b>kW</b>	<b>&lt;kW&lt;</b>			<b>CO</b>
12	6-15,5	~81%	200	0,09%

<b>PM</b>				<b>EEl</b>
16	240	155	527x371	106,71

Wyposażenie/Equipment/Ausstattung/Оборудование/  
 Vybavení/Equipment/Εξοπλισμός/Attrezzatura/Equipamiento:

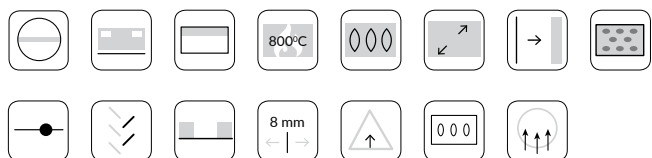

Dodatkové opcje/Additional options/Zusätzliche Optionen/  
 /Дополнительные опции/Dodatečné vybavení/Options supplémentaires/  
 Επιπλέον επιλογές/Opcioni aggiuntive/Opciones adicionales:

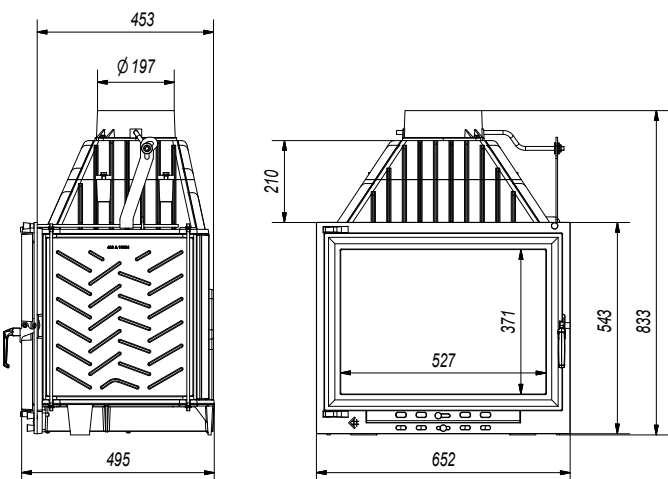
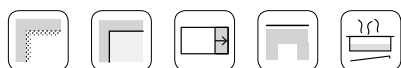

ZUZIA/ECO



ZUZIA/ECO/L/BS/DECO



ZUZIA/ECO/P/BS/DECO



ZUZIA/ECO/DECO



ZUZIA ECO

# ZOSIA ECO



≥ 900 cm<sup>2</sup>

≥ 700 cm<sup>2</sup>

A+

kW

12

<kW<

6-15,5

~83%

200

CO

0,10%

PM

22

209

194

639x465

EEI

109,32

Wyposażenie/Equipment/Ausstattung/Оборудование/  
 Vybavení/Equipement/Εξοπλισμός/Attrezzatura/Equipamiento:

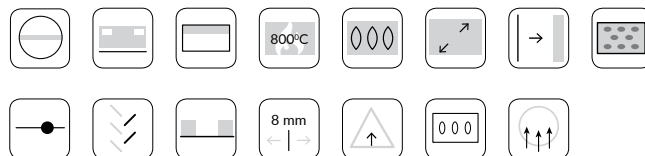

Dodatkové opcje/Additional options/Zusätzliche Optionen:  
 /Дополнительные опции/ Dodatečné vybavení/Options supplémentaires/  
 Επιπλέον επιλογές/Opzioni aggiuntive/ Opciones adicionales:

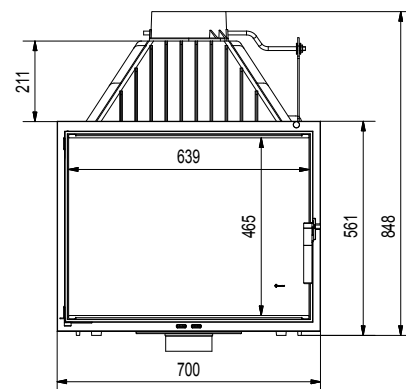
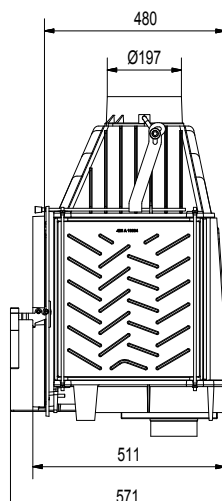
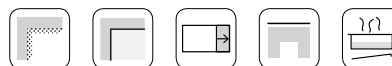

ZOSIA/PF



ANTEK/DECO



ANTEK/G



ANTEK

## ANTEK



≥ 700 cm<sup>2</sup>

≥ 500 cm<sup>2</sup>

C

<b>kW</b> 10	<b>&lt;kW&lt;</b> 6-13	 ~70%	 180	<b>CO</b> 0,61%
<b>PM</b> 99,7	 352	 91	 472x347	<b>EEl</b> 81,91

Wyposażenie/Equipment/Ausstattung/Оборудование/  
 Vybavení/Equipement/Εξοπλισμός/Attrezzatura/Equipamiento:

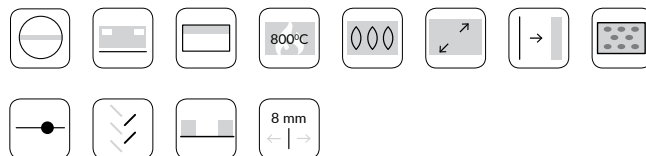

Dodatkové opcje/Additional options/Zusätzliche Optionen:  
 /Дополнительные опции/Dodatečné vybavení/Options supplémentaires/  
 Επιπλέον επιλογές/Opczioni aggiuntive/Opciones adicionales:

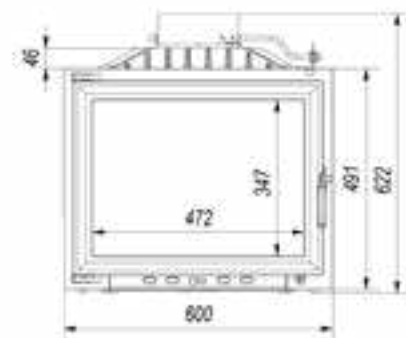

ANTEK/PF



MAJA/DECO



MAJA/L



MAJA/P



MAJA/LP



MAJA/L/BS/G



MAJA/P/BS/G



MAJA/L/BS



MAJA/P/BS



MAJA

# MAJA



≥ 700 cm<sup>2</sup>

≥ 500 cm<sup>2</sup>



8



3-10



~80%



200



0,10%



23



238



114



472x347



105,40

Wyposażenie/Equipment/Ausstattung/Оборудование/  
 Vybavení/Equipement/Εξοπλισμός/Attrezzatura/Equipamiento:

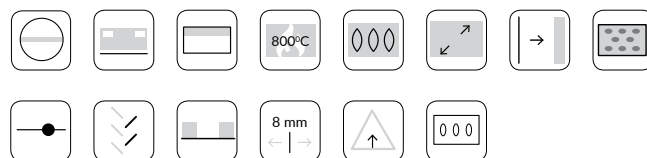

Dodatkowe opcje/Additional options/Zusätzliche Optionen:  
 /Дополнительные опции/Дodatečné vybavení/Options supplémentaires/Επιπλέον επιλογές/Opzioni aggiuntive/ Opciones adicionales:



MAJA/G



MAJA/L/BS/DECO



MAJA/P/BS/DECO

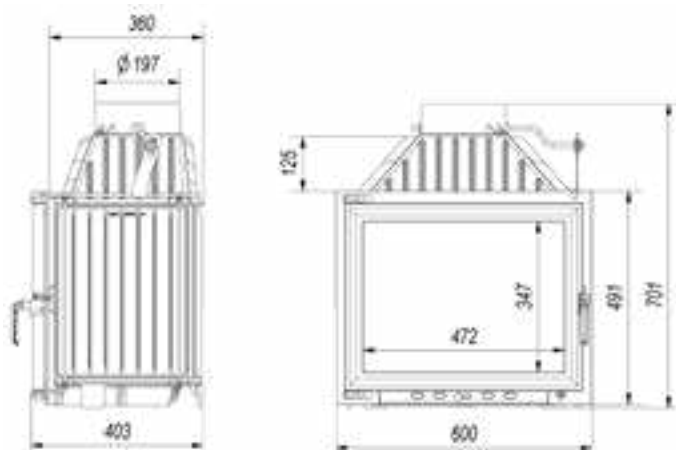

MAJA/PF

# ERYK



≥ 900 cm<sup>2</sup>

≥ 700 cm<sup>2</sup>

**A**

<b>kW</b>	<b>&lt;kW&lt;</b>			<b>CO</b>
12	8-16	~70%	200	0,61%

<b>PM</b>				<b>EEl</b>
99,7	352	103	527x371	92,35

Wyposażenie/Equipment/Ausstattung/Оборудование/  
 Vybavení/Equipement/Εξοπλισμός/Attrezzatura/Equipamiento:

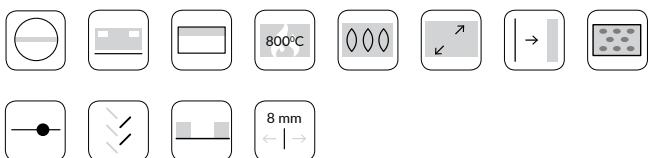

Dodatkové opcje/Additional options/Zusätzliche Optionen:  
 /Дополнительные опции/Dodatečné vybavení/Options supplémentaires/  
 Επιπλέον επιλογές/Opcioni aggiuntive/Opciones adicionales:

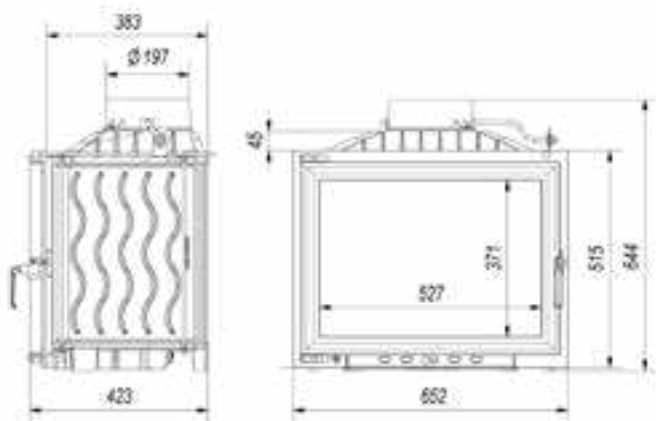

ERYK/PF



ERYK/DECO



ERYK/G



ERYK/700



ERYK/LUX





ERYK

## WIKTOR



≥ 900 cm<sup>2</sup>

≥ 700 cm<sup>2</sup>

A

kW

14

<kW<

7-18

~70%

200

CO

0,61%

PM

99,7

°C

352

kg

124

613x371

EEI

92,35

Wyposażenie/Equipment/Ausstattung/Оборудование/  
Vybavení/Equipement/Εξοπλισμός/Attrezzatura/Equipamiento:

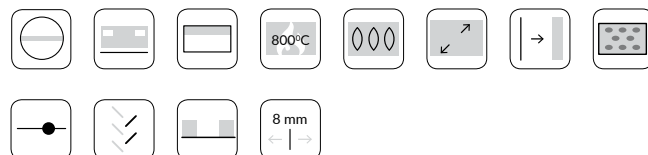

Dodatkowe opcje/Additional options/Zusätzliche Optionen:  
/Дополнительные опции/Dodatečné vybavení/Options supplémentaires/  
Επιπλέον επιλογές/Opzioni aggiuntive/Opciones adicionales:



WIKTOR/DECO



WIKTOR/R



WIKTOR/G

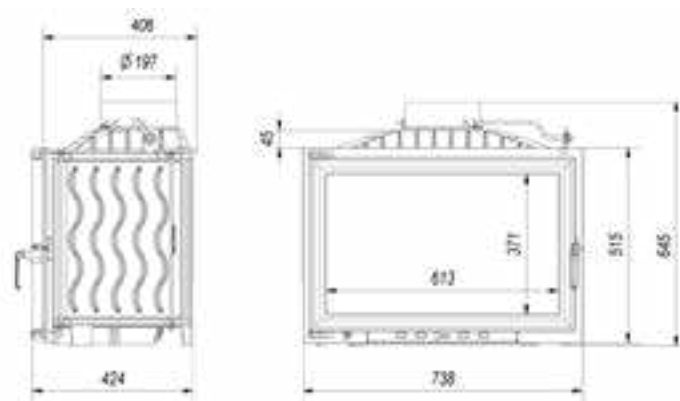

WIKTOR/PF

# ZUZIA



≥ 1000 cm<sup>2</sup>

≥ 800 cm<sup>2</sup>

**A**

<b>kW</b>	<b>&lt;kW&lt;</b>			<b>CO</b>
16	7,5-21	~76%	200	0,50%

<b>PM</b>				<b>EEl</b>
-	355	150	527x371	100,18

Wyposażenie/Equipment/Ausstattung/Оборудование/  
 Vybavení/Equipement/Εξοπλισμός/Attrezzatura/Equipamiento:

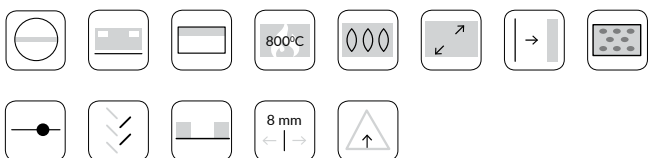

Dodatkové opcje/Additional options/Zusätzliche Optionen:  
 /Дополнительные опции/Dodatečné vybavení/Options supplémentaires/  
 Επιπλέον επιλογές/Opcioni aggiuntive/Opciones adicionales:

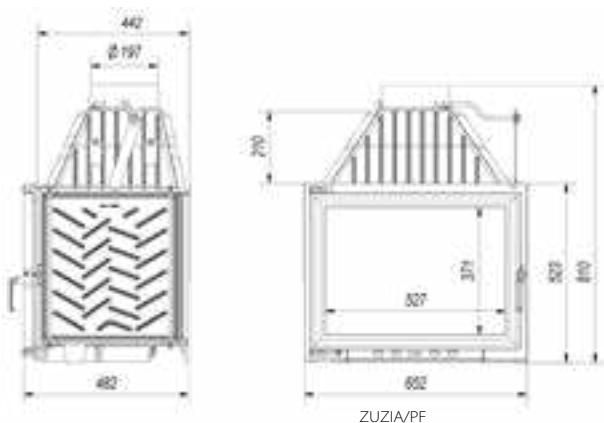
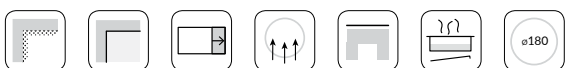

ZUZIA/PF



ZUZIA/DECO



ZUZIA/L



ZUZIA/P



ZUZIA/LPT



ZUZIA/LUX



ZUZIA/L/BS/DECO



ZUZIA P BS



ZUZIA/LP



ZUZIA/T



ZUZIA/LT



ZUZIA/PT



ZUZIA/L/BS



ZUZIA/P/BS



ZUZIA/P/BS/DECO



ZUZIA/G



ZUZIA/L/BS/G



ZUZIA/P/BS/G



ZUZIA/700

# FELIX



≥ 1000 cm<sup>2</sup>

≥ 800 cm<sup>2</sup>

**A**

<b>KW</b>	<b>&lt;KW&lt;</b>			<b>CO</b>
16	8-22	~73%	200	0,61%

<b>PM</b>				<b>EEl</b>
99,7	352	135	613x461	96,27

Wyposażenie/Equipment/Ausstattung/Оборудование/  
 Vybavení/Equipement/Εξοπλισμός/Attrezzatura/Equipamiento:

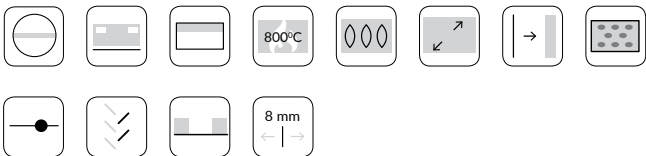

Dodatkowe opcje/Additional options/Zusätzliche Optionen:  
 /Дополнительные опции/Dodatečné vybavení/Options supplémentaires/  
 Επιπλέον επιλογές/Opcioni aggiuntive/Opciones adicionales:

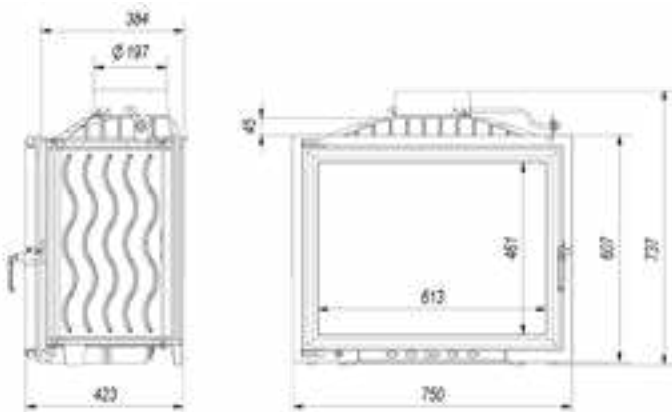

FELIX/PF



FELIX/DECO

FELIX/LUX

FELIX/G



FELIX R



OLIVIA/DECO



OLIVIA/L



OLIVIA/P



OLIVIA/LP



OLIVIA/L/BS



OLIVIA/P/BS



OLIVIA/L/BS/DECO



OLIVIA/P/BS/DECO



OLIVIA/G



OLIVIA/L/BS/G



OLIVIA/P/BS/G



OLIWIA L BS G

# OLIWIA



≥ 1000 cm<sup>2</sup>

≥ 800 cm<sup>2</sup>

**A**

<b>kW</b> 18	<b>&lt;kW&lt;</b> 9-23	 ~79%	 200	<b>CO</b> 0,15%
<b>PM</b> 31	 383	 166	 613x371	<b>EEl</b> 104,10

Wyposażenie/Equipment/Ausstattung/Оборудование/  
 Vybavení/Equipement/Εξοπλισμός/Attrezzatura/Equipamiento:

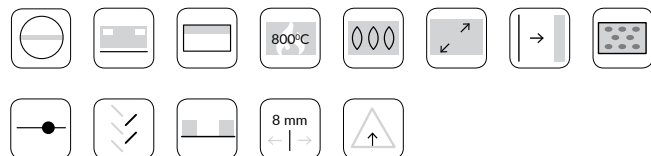

Dodatkowe opcje/Additional options/Zusätzliche Optionen:  
 /Дополнительные опции/Dodatečné vybavení/Options supplémentaires/  
 Επιπλέον επιλογές/Opczioni aggiuntive/Opciones adicionales:

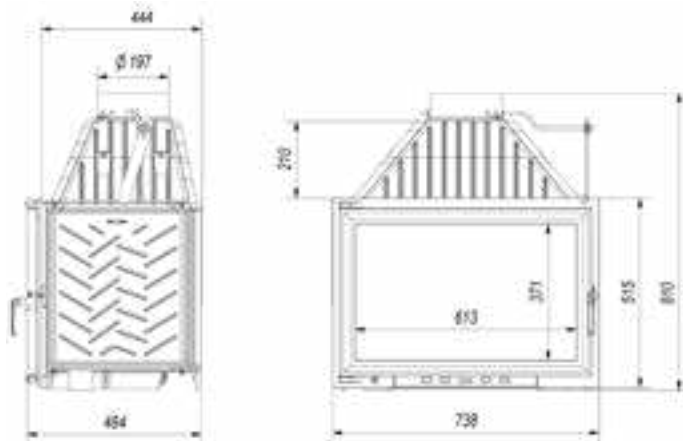

OLIWIA/PF



AMELIA/DECO



AMELIA/L



AMELIA/P



AMELIA/LP



AMELIA/T



AMELIA/LT



AMELIA/LPT



AMELIA/LUX



AMELIA/L/BS/DECO



AMELIA/P/BS/DECO



AMELIA/G



AMELIA/L/BS/G





AMELIA

# AMELIA



≥ 1000 cm<sup>2</sup>

≥ 800 cm<sup>2</sup>

**A**

<b>kW</b> 21	<b>&lt;kW&lt;</b> 11,5-29	~75%	200	<b>CO</b> 0,22%
<b>PM</b> 80,6	390	181	613x461	<b>EEl</b> 98,88

Wyposażenie/Equipment/Ausstattung/Оборудование/  
Vybavení/Equipement/Εξοπλισμός/Attrezzatura/Equipamiento:

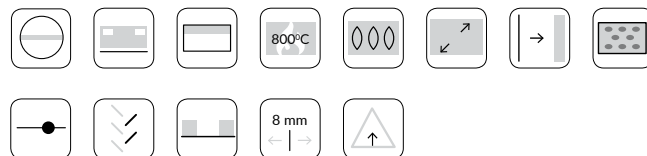

Dodatkowe opcje/Additional options/Zusätzliche Optionen:  
/Дополнительные опции/Dodatečné vybavení/Options supplémentaires/Επιπλέον επιλογές/Opzioni aggiuntive/ Opciones adicionales:



AMELIA/PT



AMELIA/L/BS



AMELIA/P/BS



AMELIA/P/BS/G

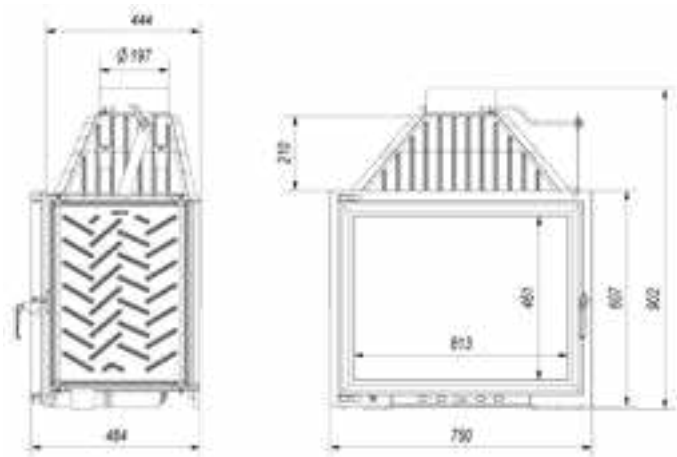

AMELIA/PF





# MAJA WIEŻA



≥ 900 cm<sup>2</sup>

≥ 700 cm<sup>2</sup>

A



15



7-19,5



~71%



200



0,56%



55,8



227



169



471x760



93,66

Wyposażenie/Equipment/Ausstattung/Оборудование/  
 Vybavení/Equipement/Εξοπλισμός/Attrezzatura/Equipamiento:



Dodatkowe opcje/Additional options/Zusätzliche Optionen:  
 /Дополнительные опции/Додаточné vybavení/Options supplémentaires/  
 Επιπλέον επιλογές/Opzioni aggiuntive/ Opciones adicionales:

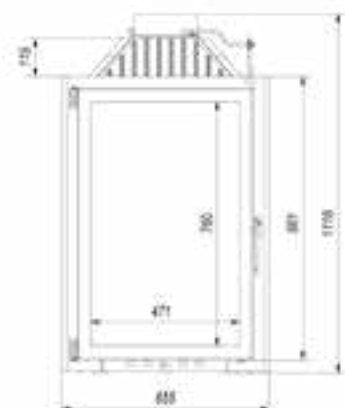

MAJA W

MAJAW





# SIMPLE



SIMPLE/M/S/L/BS

≥ 700 cm<sup>2</sup>

≥ 500 cm<sup>2</sup>

**A**

kW

8

<kW<

3-10

~80%

~80%

200

200

CO

0,10%

PM

25

°C

238

kg

115

563x347

563x347

EEI

105,40

Wyposażenie/Equipment/Ausstattung/Оборудование/  
 Vybavení/Equipement/Εξοπλισμός/Attrezzatura/Equipamiento:



SIMPLE/M/S/P/BS

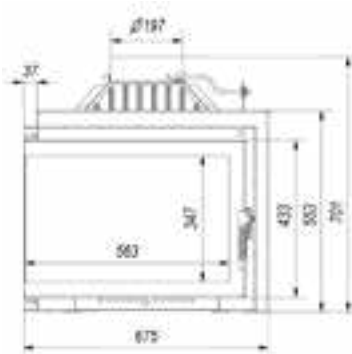

SIMPLE/M/S/L/BS

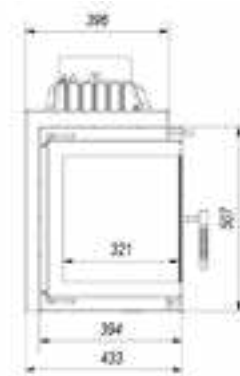

SIMPLE/M/S/P/BS

# KASETA/KDZ



kW	<kW<			CO
6	3,5-8	~78,5%	-	0,10%

PM				EEI
38	355	110	580x342	104,2

Wyposażenie/Equipment/Ausstattung/Оборудование/  
 Vybavení/Equipement/Εξοπλισμός/Attrezzatura/Equipamiento:

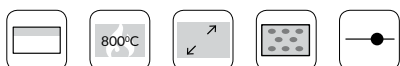

# KASETA/KDZ/K



≥ 700 cm<sup>2</sup>

≥ 500 cm<sup>2</sup>



kW	<kW<			CO
6	3,5-8	~78,5%	160	0,10%

PM				EEI
38	355	110	580x342	104,2

Wyposażenie/Equipment/Ausstattung/Оборудование/  
 Vybavení/Equipement/Εξοπλισμός/Attrezzatura/Equipamiento:

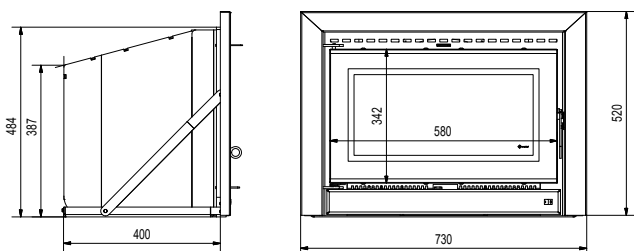
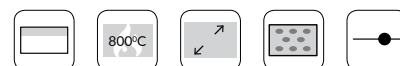



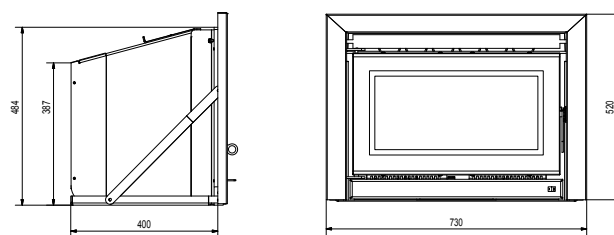









KASETA/KDZ/K



KASETA/KDZ



															
Franek 10	10	5.0 - 13.0	80	0,10	25	105,4	265	180	A	✓	✓	✓	190	40	542x443
Franek 12	12	5.0 - 14.5	82	0,09	34	108,01	215	200	A+	✓	✓	✓	249	50	639x493
Franek 14	14	6.0 - 17.0	81	0,10	19	106,71	250	200	A	✓	✓	✓	276	60	739x460
Zuzia Eco	12	6.0-15.5	81	0,09	16	106,71	240	200	A	✓		✓	155	50	527x371
Zosia Eco	12	6.0-15.5	83	0,10	22	109,32	209	200	A+	✓	✓	✓	194	50	639x465
Antek	10	6.0 - 13.0	62	0,61	99,7	81,91	352	180	C			✓	91	33	472x347
Maja	8	3.0 - 10.0	80	0,10	23	105,4	238	200	A			✓	114	33	472x347
Eryk	12	8.0 - 16.0	70	0,61	99,7	92,35	352	200	A			✓	103	35	613x371
Wiktor	14	7.0 - 18.0	70	0,61	99,7	92,35	352	200	A			✓	124	45	630x393
Zuzia	16	7.5 - 21.0	76	0,50	-	100,18	355	200	A			✓	150	50	527x371
Felix	16	8.0 - 22.0	73	0,61	99,7	96,27	352	200	A			✓	135	45	613x461
Oliwia	18	9.0 - 23.0	79	0,15	31	104,1	383	200	A			✓	166	50	613x371
Amelia	21	11.5 - 29.0	75	0,22	80,6	98,88	390	200	A			✓	181	50	613x461
Maja Wieża	15	7.0 - 19.5	71	0,56	55,8	93,66	227	200	A				169	33	471x760
SIMPLE	8	3 - 10	80	0,10	25	105,40	238	200	A	✓		✓	115	33	563x347
KASETA/KDZ	6	3.5 - 8.5	78,8	0,10	38	104,2	355		A	✓		✓	110	30	580x342
KASETA/KDZ/K	6	3.5 - 8.5	78,8	0,10	38	104,2	355	160	A	✓		✓	110	30	580x342



≥m²f	≥m²l	—	L	L	=	+	↑↓	↑↓	DECO	DECO	DECO	Z	↑↑	↻	DECO	L
≥700	≥500	✓										✓	✓		✓	✓
≥900	≥700	✓										✓	✓		✓	✓
≥1000	≥800	✓										✓	✓		✓	✓
≥900	≥700	✓							✓	✓	✓	✓	✓		✓	✓
≥900	≥700	✓							✓	✓	✓	✓	✓		✓	✓
≥700	≥500	✓			✓	✓	✓		✓			✓			✓	
≥500	≥700	✓	✓	✓	✓	✓	✓	✓	✓	✓	✓	✓			✓	
≥900	≥700	✓			✓	✓			✓			✓			✓	
≥900	≥700	✓			✓	✓			✓			✓			✓	
≥1000	≥800	✓	✓	✓	✓	✓	✓	✓	✓	✓	✓	✓			✓	
≥1000	≥800	✓			✓	✓			✓			✓			✓	
≥1000	≥800	✓	✓	✓	✓	✓	✓	✓	✓	✓	✓	✓			✓	
≥1000	≥800	✓	✓	✓	✓	✓	✓	✓	✓	✓	✓	✓			✓	
≥900	≥700	✓										✓	✓		✓	
≥700	≥500		✓	✓					✓			✓		✓		
												✓			✓	✓
≥700	≥500											✓		✓	✓	✓



# Uważamy, że nie ma nic przyjemniejszego niż ciepła atmosfera domowego zacisza...

„We believe that there is nothing better than a welcome atmosphere of domestic seclusions...”

„Wir glauben, dass es nichts Angenehmeres gibt, als warme Atmosphäre des häuslichen Herdes...”

„Мы считаем, что нет ничего лучше, чем тёплая атмосфера домашнего уюта вдали от дома...”

„Máme za to, že není nic příjemnějšího, než teplé domácí prostředí...”

„Nous croyons qu’il n’y a rien de mieux qu’une ambiance chaleureuse de la maison...”

„Πιστεύουμε, ότι δεν υπάρχει τίποτα καλύτερο από μια ζεστή ατμόσφαιρα σπιτικής ηρεμίας...”

„Rediamo non non c’è niente più piacevole dell’atmosfera calda delle mura domestiche...”

„No hay nada mejor que una cálida bienvenida al hogar...”



## WYPOSAŻENIE WKŁADÓW WODNYCH

Advantages of water inserts/Vorteile der wasserführenden Kamineinsätze/Преимущества топков с водяным контуром/Ventajas de los hogares calefactores

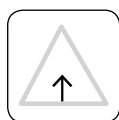

Wysoki czopuch - zwiększa powierzchnię wymiany ciepła pomiędzy gorącymi spalinami a pomieszczeniem / High flue - increases the area of heat exchange between the hot exhaust gases and the room / Hoher Kaminfuchs - vergrößert die Heizfläche / Высокий дымоход - увеличивает поверхность теплообмена между горячими выхлопными газами и комнатой / Vysoký sopouch, zvětšuje plochu výměny tepla mezi horkými spalinami a místností / Partie supérieure du foyer (l'avaloir des fumées) - augmente la surface d'échange de chaleur entre les fumées chaudes et l'air environnant / Κωνικός εναλλάκτης καυσαερίων εστίας. Μεγαλώνει την επιφάνεια εναλλαγής θερμών καυσαερίων από τον θάλαμο καύσης προς τον εξωτερικό χώρο της εστίας / Camino alto - deve aumentare l'area superficiale scambio termico nel focolare con camicia d'acqua / Cabezal alto - incrementa el area de intercambio de calor entre la salida de gases y el ambiente

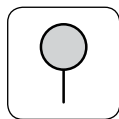

Szpilki wzmacniające płaszcz wodny oraz materiał, blacha kotłowa 4mm, gwarantują bezawaryjną pracę kominka / Reinforcing pins for fireplaces with water jacket and material, 4mm boiler plate, ensure reliable operation of the fireplace / Verstärkungselemente des Kaminwassermantels und Kesselstahl gewährleistet eine störungsfreie Arbeit des Kamineinsatzes / Укрепление водяного контура и котельная сталь 4мм, обеспечивают бесперебойной работы / Kolíky pro upevnění vodního pláště a použitý materiál, Kotlová ocel, zaručují bezporuchový provoz krbu / Epingles, renforçant la solidité des doubles parois, et le matériau (tôle chaudière 4 mm) garantissent le fonctionnement du foyer sans problème / Ειδικά καρφιά στερέωσης του συστήματος νερού καθώς και ο χάλυβας 4mm εξασφαλίζουν άσφουγη λειτουργία εστίας / Perni di rinforzo camicia d'acqua e materiale caldaia in acciaio 4 millimetri, garantire un funzionamento senza problemi del camino / Elementos de refuerzo para la paila y acero refractario para un perfecto funcionamiento del hogar



Płomieniówki - zwiększają powierzchnię wymiany ciepła w kominku / Smoke tubes - increase the heat exchange surface in a fireplace / Heizrohre - vergrößern die Wärmeaustauschfläche des Kamins / Дымоградные трубы - повышают поверхность теплообмена в топке / Žárové trubky pro vnitřní průchod spalin - zvětšují plochu výměny tepla s vodou / Petits tubes à fumées augmentent la surface d'échange de chaleur dans le foyer / Τουμπσωλήνες - μεταφέρουν την θερμότητα προς το νερό / Tubo di fumo - aumenta la superficie di scambio termico nel camino / Sistema de tubos para mejorar el intercambio de calor

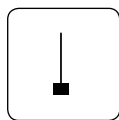

Regulowane nóżki ułatwiają wy poziomowanie wkładu / Adjustable legs for leveling a fireplace / Regulierbare FüÙe erleichtern das richtige Aufstellen des Kamineinsatzes / Регулируемые ножки, которые облегчают выравнивание топки / Patas regulables para facilitar la instalación / Regulované noÙky usnadňující nastavení krbové vložky do vodorovné polohy / Jambes réglables facilitant le positionnement correct du foyer / Ρυθμιζόμενα ποδαράκια, διευκολύνουν το αλφάδιασμα εστίας / Piedini regolabili per la facilità di focolare / Patas regulables para facilitar la instalación

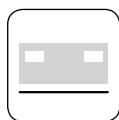

Deflektor - wydłuża drogę spalin / Deflector - extends the exhaust path / Deflektor - verlängert den Abgasweg / Встроенный дефлектор/дефлектор / Deflektor - prodlužující dráhu kouřových plynů / Déflecteur - allonge le trajet des fumées / Κόφτης, προκαλεί εκτροπή των καυσαερίων / Deflettore aumento percorso fum / Deflector - para alargar el circuito de humos

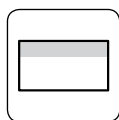

Kierownica powietrza tworząca system czystej szyby - ograniczający osadzanie się sadzy na szybie / Air clean glass-forming system - limits the deposition of soot on the glass / Luftmantel an derr Frontscheibe - verringert die Rußablagerung an der Scheibe / Управление воздухом, система чистого стекла / Přívod vzduchu na sklo pro systém čistého skla - slouží k zamezení usazování sazí na skleněné tabuli / Système „vitre propre“ par rideau d'air - atténue la suie sur la vitre / Αεροκουρτίνα, αποτρέπει το μαύρισμα τζαμιού / Sterzo aria creazione sistema pulito vetri - limitativo sedimentazione nerofumo sul vetro / Sistema de limpieza del cristal - evita que se depositen hollín en el cristal

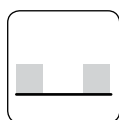

Ozdobny płotek zabezpiecza drewno przed wypadaniem z wkładu / Decorative fence protects the wood from falling out of the insert / Dekorzaun, der das Holz vom Herausfallen schützt / Заборчик защищает древесину от выпадения из топков / Dekorativni ohradník zajišťuje dříví proti vypadnutí z krbové vložky / Pare - bûches d coratif emp che les buches de tomber du foyer / Διακοσμητική ασφάλεια, προστατεύει τα ξύλα να παραμείνουν στον θάλαμο καύσης / Ostacolo decorativo protegge il legno di cadere fuori della focolare / Murillo que evita la caída de la leña fuera del insert

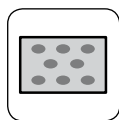

Ruchomy ruszt, dzięki któremu można łatwo wymieść popiół / Movable grate gives possibility of easily wipe away the ash / Beweglicher Rost hilft beim Reinigen / Движущиеся решетка благодаря которой Вы можете легко стереть пепел / Výmětelný rošt umožňuje snadné vymetání popelu / Grille de foyer amovible pour faciliter l'évacuation des cendres / Grille de foyer amovible pour faciliter l'évacuation des cendres / Αφαιρούμενη σχάρα, διευκολύνει τον καθαρισμό της εστίας / Griglia mobile, grazie alla quale può essere facilmente pulito cenere / Parrilla móvil para facilitar la limpieza de las cenizas

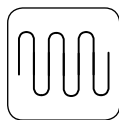

Wężownica / Coil pipe / Sicherheitswärmetauscher / Змеевик / Chladící smyčka - Dodatečné vybavení / Serpentin pour foyer chaudière - option supplémentaire / Σπιράλ ασφαλείας - επιπλέον επιλογή / Serpentina - opzione di più / Intercambiador de calor de seguridad

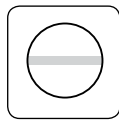

Wbudowany szyber reguluje siłę ciągu komina / Built-in damper regulates the strength of the chimney draft / Eingebauter Schieber dank dem der Kaminzug regulierbar ist / Встроенный шибер / Vestavěná klapka reguluje tah komína / Buse (sortie des fumées) intégrée - permet de régler la „force“ du tirage / Ενσωματωμένο κλαπέτο καμινάδας, το οποίο ρυθμίζει τον ελκυσμό της / Ενσωματωμένο κλαπέτο καμινάδας, το οποίο ρυθμίζει τον ελκυσμό της / Integrato serranda fumo regola l'intensità Il tiraggio della canna fumaria / Trampilla móvil para regular la combustión

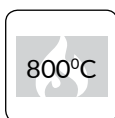

Ceramika żaroodporna wytrzymująca temperaturę do 800°C / Heat-resistant ceramic can withstand temperatures up to 800°C / Hitzbeständige Keramikscheibe bis 800 Grad / Жароупорное стекло выдерживающие температуру до 800 градусов / Žáruvzdorné sklo odolné proti teplotě do 800°C / Vitre réfractaire supporte la température jusqu'à 800°C / Πυράντοχο τζάμι, έως 800°C / Vetro resistente al calore in grado di sopportare temperature fino a 800 gradi / Cristal resistente a temperatura de 800oC

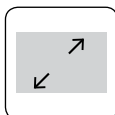

Duża komora spalania / Large combustion chamber / Großer Brennraum / Большая камера сгорания / Velká spalovací komora / Grande chambre de combustion / Μεγάλος θάλαμος καύσης / Camera di combustione grande / Amplia cámara de combustión

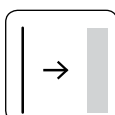

System zimnej klamki umożliwia zdjęcie klamki w momencie palenia w kominku / The system of cold handle allows to take it off during the combustion process / System des kalten Griffes ermöglicht während des Brennvorgangs den Griff abzunehmen / Система холодной ручки / Systém studené kliky umožňuje sundání kliky při topení v krbu / Système de poignée froide - possibilité d'enlever la poignée pendant la combustion dans le foyer / Αφαιρούμενο πόμολο κατά την διάρκεια λειτουργίας τζακιού, για να προστατεύεται από υπερθέρμανση / Il sistema la maniglia fredda è possibile rimuovere la maniglia al momento della combustione nel focolare / Maneta fría extraíble

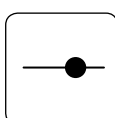

Regulacja dopływu powietrza do spalania / Regulation of air supply for combustion / Regulieren des Luftstroms durch die Aschenschublade / Регулирование притока воздуха через вынимаемый пеплосборник / Regulace přívodu vzduchu skrz popelník (primárního ke spalování) / Réglage d'arrivée d'air pour la combustion / Ρύθμιση εισαγωγής αέρα μέσω του σταχτοδοχείου (πρωτογενής καύσης) / Regolazione dell'aria primaria per la combustione / Regulación del suministro de aire para la combustión

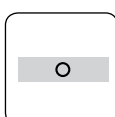

Szuflada/pojemnik na popiół, gdzie gromadzą się pozostałości po spalonym drewnie / Ash drawer/container where remains burnt wood / Aschenschublade in derer sich der Rest des verbrannten Holzes sammelt / Ящик/контейнер для пепла - здесь собираются остатки дров / Zásuvka na popel, ve které se shromažďují zbytky spáleného dříví / Tiroir à cendres sert à collecter les résidus de combustion / Συρτάρι στάχτης, διοχετεύει υπολείμματα μετά την καύση / Cassetto per cenere che si accumulano in resti di legno bruciato / Cajón cenicero - contenedor de brasas

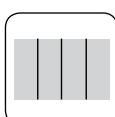

Acumotte - materiał akumulujący ciepło, który podwyższa temperaturę w komorze podnosząc efektywność spalania. / Acumotte - heat accumulating material that increases the temperature in the chamber, increasing the efficiency of combustion. / Acumotte - Wärmespeichermaterial, das die Temperatur in der Kammer erhöht und die Effizienz der Verbrennung erhöht. / Acumotte - теплонакопительный материал, который увеличивает температуру в камере, повышая эффективность сгорания / Acumotte - tepelně akumuláční materiál, který zvyšuje teplotu v komoře a zvyšuje účinnost spalování. / Acumotte - matériau d'accumulation de chaleur qui augmente la température dans la chambre, ce qui augmente l'efficacité de la combustion. / Acumotte - υλικό συσσώρευσης θερμότητας που αυξάνει τη θερμοκρασία στο θάλαμο, αυξάνοντας την απόδοση της καύσης. / Acumotte - materiale che accumula calore che aumenta la temperatura nella camera, aumentando l'efficienza della combustione.

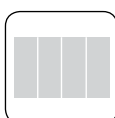

Termotec - materiał akumulujący ciepło, który podwyższa temperaturę w komorze podnosząc efektywność spalania. / Termotec - heat accumulating material that increases the temperature in the chamber, increasing the efficiency of combustion. / Termotec - Wärmespeichermaterial, das die Temperatur in der Kammer erhöht und die Effizienz der Verbrennung erhöht. / Termotec - теплонакопительный материал, который увеличивает температуру в камере, повышая эффективность сгорания / Termotec - tepelně akumuláční materiál, který zvyšuje teplotu v komoře a zvyšuje účinnost spalování. / Termotec - matériau d'accumulation de chaleur qui augmente la température dans la chambre, ce qui augmente l'efficacité de la combustion. / Termotec - υλικό συσσώρευσης θερμότητας που αυξάνει τη θερμοκρασία στο θάλαμο, αυξάνοντας την απόδοση της καύσης. / Termotec - materiale che accumula calore che aumenta la temperatura nella camera, aumentando l'efficienza della combustione.

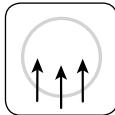

Dolot powietrza - króciec montowany do wkładu kominkowego, który ma na celu doprowadzenie świeżego powietrza do paleniska z zewnątrz budynku - dodatkowa opcja / External air inlet - special connector mounted in fireplace insert, which provides fresh air directly from outside - additional option / Externluftzufuhr - spezieller Stutzen, der am Kamineinsatz eingebaut wird, um frische Luft von außen für den Verbrennungsprozess zuzuführen - zusätzliche Option / Приток воздуха - Устройство для подвода воздуха в камеру сгорания - дополнительный выбор / Přívod externího vzduchu - nástavec namontovaný v krbové vložce sloužící k přivádění čerstvého vzduchu z vnějšku budovy / Entrée d'air d'extérieur - tubulure spéciale intégrée avec le foyer qui fournit l'air extérieur à la chambre de combustion / Εξάρτημα, χάρη στο οποίο γίνεται εισαγωγή εξωτερικού αέρα στον θάλαμο καύσης / Ingresso aria - connettore montato a focolare che deve alimentazione di fresco nella camera di combustione dall'esterno palazzo / Entrada de aire del exterior - conector especial montado en la chimenea para conectar la entrada de aire de combustión del exterior - opción adicional

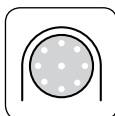

System unoszenia drzwi / Lift-up door system / System der Türanhebung / Тросовой механизм поднятия гильотины, тросовой механизм поднятия гильотины скольжения дверцы / Systém výsuvu dvířek nahoru / Système pour soulever la porte / Σύστημα συρόμενης πόρτας / Sistema alzare porta / Sistema para la puerta de guillotina

## WYPOSAŻENIE WKŁADÓW AQUARIO

Advantages of AQUARIO inserts/Vorteile der AQUARIO Kamineinsätze/Преимущества топков AQUARIO/ Ventajas de los hogares aquario

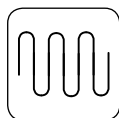

Wężownica / Coil pipe / Sicherheitswärmetauscher / Змеевик / Chladící smyčka - Dodatečné vybavení / Serpentin pour foyer chaudière - option supplémentaire / Σπιδράλ ασφαλείας - επιπλέον επιλογή / Serpentina - opzione di più / Intercambiador de calor de seguridad



Nagrzewnica pionowa - układ rurek pionowych zwiększających powierzchnię styku wody z czynnikiem grzewczym, czyli spalinami / Vertical heater - vertical pipe system to increase the contact surface of the water with the heating surface/gases / Vertikale Heizrohren ist eine natürliche Konvektionkanal für Abgasstrom / Вертикальный нагреватель - система вертикальных трубок, увеличивающих поверхность стыка воды с нагревательным прибором (выхлопными газами) / Vertikální výměník - svislý potrubní systém pro zvýšení kontaktní plochy vody s topným médiem, čili spalinami / Échangeurs de chaleur verticaux - système de tuyaux verticaux pour augmenter la surface de contact et d'échange entre l'eau et les gaz chauds de combustion / Κάθετοι τουμποσωλήνες - αυξάνουν την επιφάνεια επαφής νερού με την πηγή θερμότητας - τα καπναέρια / Riscaldatore verticale - un sistema verticale dei tubi, che aumenta area dove l'acqua arriva al gas scarico / Tubos de calefacción verticales que representan un canal natural para la salida de los gases

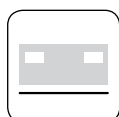

Deflektor - wydłuża drogę spalin / Deflector - extends the exhaust path / Deflektor - verlängert den Abgasweg / Встроенный дефлектор/дефлектор / Deflektor - produžující dráhu kouřových plynů / Déflecteur - allonge le trajet des fumées / Κόφτης, προκαλεί εκτροπή των καυσαερίων / Deflettore aumento percorso fum / Deflector - para alargar el circuito de humos

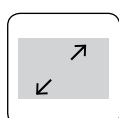

Duża komora spalania wyłożona Acumotte (system otworów w ścianie tylnej odpowiada za napowietrzenie komory spalania) / Large combustion chamber - lined with Acumotte (system of holes in the back wall is in charge of the aeration of the combustion chamber) / Die Brennkammer ist mit Acumotte ausgelegt - dieses Material verbessert die Arbeitsparameter des Heizeinsatzes / Большая камера сгорания выложена акумотте / Velká spalovací komora obložená vermikulitem (systém otvorů v zadní stěně pro sekundární spalování) / Grande chambre de combustion - les parois sont recouvertes d'Acumotte (l'Acumotte est munie d'une série de trous qui favorisent une aération adéquate de la chambre de combustion) / Εστία χωρίς σχαράκι και συρτάρι στάχτης - η καύση υψηλών θερμοκρασιών ελαττώνει σημαντικά την δημιουργία στάχτης / Άμπρια camera di combustione rivestita con acumotte (sistema dei fori nella parete posteriore e' responsabile per l'aerazione della camera di combustione) / Cámara de combustión revestida con Acumotte - material que mejora los parámetros de trabajo del hogar

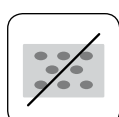

Wkład bezrusztowy - dopalanie na popiele / Fireplace without grate - the combustion takes place over the entire width of the fireplace / Brennkammer ohne Rost- Ascheabbrennung / Безрешетчатая вставка - дожигание пепла / Bezroštová vložka - dodatečné spalování na popelu / Il n'y a pas de grille à cendre - la combustion a lieu sur toute la surface de la chambre de combustion / Εστία χωρίς σχαράκι και συρτάρι στάχτης - η καύση υψηλών θερμοκρασιών ελαττώνει σημαντικά την δημιουργία στάχτης / L'inserto senza griglia - brucia in cenere / Cámara de combustión sin rejilla - combustión de las cenizas

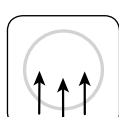

Dolot powietrza - króciec montowany do wkładu kominkowego, który ma na celu doprowadzenie świeżego powietrza do paleniska z zewnątrz budynku - dodatkowa opcja / External air inlet - special connector mounted in fireplace insert, which provides fresh air directly from outside - additional option / Externluftzufuhr - spezieller Stutzen, der am Kamineinsatz eingebaut wird, um frische Luft von außen für den Verbrennungsprozess zuzuführen - zusätzliche Option / Приток воздуха - Устройство для подвода воздуха в камеру сгорания - дополнительный выбор / Přívod externího vzduchu - nástavec namontovaný v krbové vložce sloužící k přivádění čerstvého vzduchu z vnějšku budovy / Entrée d'air d'extérieur - tubulure spéciale intégrée avec le foyer qui fournit l'air extérieur à la chambre de combustion / Εξάρτημα, χάρη στο οποίο γίνεται εισαγωγή εξωτερικού αέρα στον θάλαμο καύσης / Ingresso aria - connettore montato a focolare che deve alimentazione di fresco nella camera di combustione dall'esterno palazzo / Entrada de aire del exterior - conector especial montado en la chimenea para conectar la entrada de aire de combustión del exterior - opción adicional

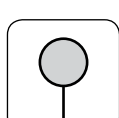

Szpilki wzmacniające płaszcz wodny oraz materiał, blacha kotłowa 4mm, gwarantują bezawaryjną pracę kominka / Reinforcing pins for fireplaces with water jacket and material, 4mm boiler plate, ensure reliable operation of the fireplace / Verstärkerungselemente des Kaminwassermantels und Kesselstahl gewährleistet eine störungsfreie Arbeit des Kamineinsatzes / Укрепление водяного контура и котельная сталь 4мм, обеспечивают бесперебойной работу / Kolíky pro upevnění vodního pláště a použitý materiál, Kotlová ocel, zaručují bezporuchový provoz krbu / Epingles, renforcent la solidité des doubles parois, et le matériau (tôle chaudière 4 mm) garantissent le fonctionnement du foyer sans problème / Ειδικά καρφιά στερέωσης του συστήματος νερού καθώς και ο χάλυβας 4μμ εξασφαλίζουν άφορη λειτουργία εστίας / Perni di rinforzo camicia d'acqua e materiale caldaia in acciaio 4 millimetri, garantire un funzionamento senza problemi del camino / Elementos de refuerzo para la paila y acero refractario para un perfecto funcionamiento del hogar

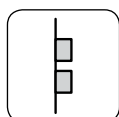

Dwuszybrowa regulacja wylotu spalin / Double-damper regulation of gas / Kaminzug durch zwei Schieber regulierbar / встроенный шибер - регулирует тягу дымохода / Vestavěná klapka - k regulaci komínového tahu / Double réglages de la sortie des gaz de combustion / Αεροκουρτίνα, αποτρέπει το μαύρισμα τζαμιού / Uscita di gas scarico regolabile da due serrande / Tiro regulable mediante dos tiradores

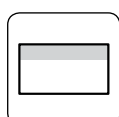

Kierownica powietrza tworząca system czystej szyby - ograniczający osadzenie się sadzy na szybie / Air clean glass-forming system - limits the deposition of soot on the glass / Luftmantel an der Frontscheibe - verringert die Rußablagerung an der Scheibe / Управление воздухом, система чистого стекла / Přívod vzduchu na sklo pro systém čistého skla - sloužící k zamezení usazování sazí na skleněné tabuli / Système „vitre propre" par rideau d'air - atténue la suie sur la vitre / Αεροκουρτίνα, αποτρέπει το μαύρισμα τζαμιού / Sterzo aria creazione sistema pulito vetri - limitativo sedimentazione nerofumo sul vetro / Sistema de limpieza del cristal - evita que se deposite hollín en el cristal

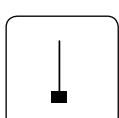

Regulowane nóżki ułatwiające wypoziomowanie wkładu / Adjustable legs for leveling a fireplace / Regulierbare Füße erleichtern das richtige Aufstellen des Kamineinsatzes / Регулируемые ножки, которые облегчают выравнивание топки / Patas regulables para facilitar la instalación / Regulované nožky usnadňující nastavení krbové vložky do vodorovné polohy / Jambes réglables facilitant le positionnement correct du foyer / Ρυθμιζόμενα ποδαρικά, διευκολύνουν το αλφάδιασμα εστίας / Piedini regolabili per la facilità di focolare / Patas regulables para facilitar la instalación

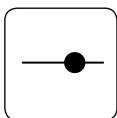

Regulacja dopływu powietrza do spalania / Regulation of air supply for combustion / Regulieren des Luftstroms durch die Aschenschublade / Регулирование притока воздуха через вынимаемый пеплосборник / Regulace přívodu vzduchu skrz popelník (primárního ke spalování) / Réglage d'arrivée d'air pour la combustion / Ρύθμιση εισαγωγής αέρα μέσω του σταχτοδοχείου (πρωτογενής καύσης) / Regolazione dell'aria primaria per la combustione / Regulación del suministro de aire para la combustión

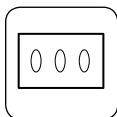

System dopalania spalin - ogranicza emisję szkodliwych substancji do środowiska / Post-combustion flue gas system - reduces emissions of harmful substances into the environment / Zusätzliche Verbrennung der Abgase - verringert die Emissionen der schädlichen Substanzen in die Atmosphäre / Система дожигаания выхлопных газов - Ограничение выбросов вредных веществ для окружающей среды / Systém přídavného spalování zplodin hoření (omezuje emisi škodlivých látek do ovzduší) / Système de double combustion - limite l'émission de substances nocives dans l'environnement / Σύστημα δευτερογενής καύσης (περιορίζει την εκπομπή καπναερίων στην ατμόσφαιρα) / Il sistema combustione di gas di scarico - riduzione delle emissioni di sostanze nocive all'ambiente / Post-combustión - combustión adicional que reduce las emisiones de sustancias nocivas en el medio ambiente

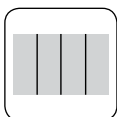

Acumotte - materiał akumulujący ciepło, który podwyższa temperaturę w komorze podnosząc efektywność spalania. / Acumotte - heat accumulating material that increases the temperature in the chamber, increasing the efficiency of combustion. / Acumotte - Wärmespeichermaterial, das die Temperatur in der Kammer erhöht und die Effizienz der Verbrennung erhöht. / Acumotte - теплонакопительный материал, который увеличивает температуру в камере, повышая эффективность сгорания / Acumotte - tepelně akumuláční materiál, který zvyšuje teplotu v komoře a zvyšuje účinnost spalování. / Acumotte - matériau d'accumulation de chaleur qui augmente la température dans la chambre, ce qui augmente l'efficacité de la combustion. / Acumotte - υλικό συσσώρευσης θερμότητας που αυξάνει τη θερμοκρασία στο θάλαμο, αυξάνοντας την απόδοση της καύσης. / Acumotte - materiale che accumula calore che aumenta la temperatura nella camera, aumentando l'efficienza della combustione.

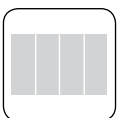

Termotec - materiał akumulujący ciepło, który podwyższa temperaturę w komorze podnosząc efektywność spalania. / Termotec - heat accumulating material that increases the temperature in the chamber, increasing the efficiency of combustion. / Termotec - Wärmespeichermaterial, das die Temperatur in der Kammer erhöht und die Effizienz der Verbrennung erhöht. / Termotec - теплонакопительный материал, который увеличивает температуру в камере, повышая эффективность сгорания / Termotec - tepelně akumuláční materiál, který zvyšuje teplotu v komoře a zvyšuje účinnost spalování. / Termotec - matériau d'accumulation de chaleur qui augmente la température dans la chambre, ce qui augmente l'efficacité de la combustion. / Thermotec - υλικό συσσώρευσης θερμότητας που αυξάνει τη θερμοκρασία στο θάλαμο, αυξάνοντας την απόδοση της καύσης. / Termotec - materiale che accumula calore che aumenta la temperatura nella camera, aumentando l'efficienza della combustione.

# MBM PW 10



kW	<kW<	kW <sub>0</sub>		CO	bar
12	5-14	7	~85%	0,10%	2

PM				EEI	
27	185	232	180	111,9	26,5

Wyposażenie/Equipment/Ausstattung/Оборудование/  
 Vybavení/Equipement/Εξοπλισμός/Attrezzatura/Equipamiento:

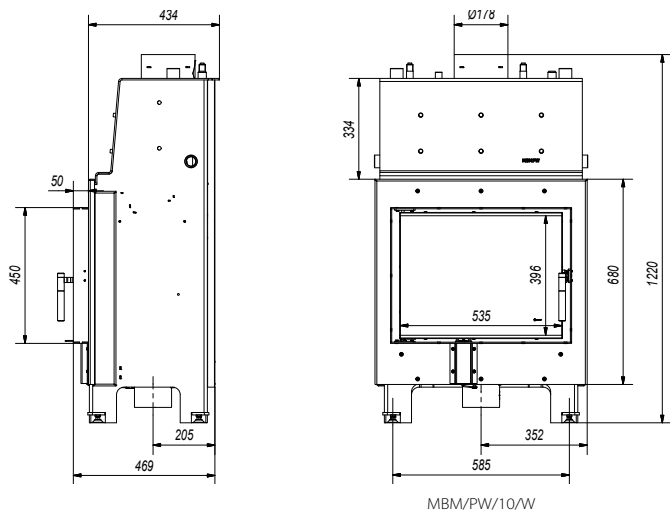
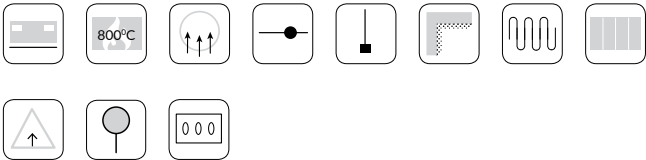





MBM PW 10

## MBZ PW 13



kW	<kW<	kW0		CO	bar
13	6-16	7	~81%	0,10%	2
PM				EEI	
32	230	262	200	106,71	35

Wyposażenie/Equipment/Ausstattung/Оборудование/  
 Vybavení/Equipement/Εξοπλισμός/Attrezzatura/Equipamiento:

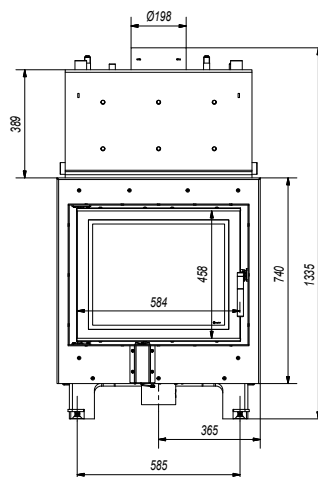
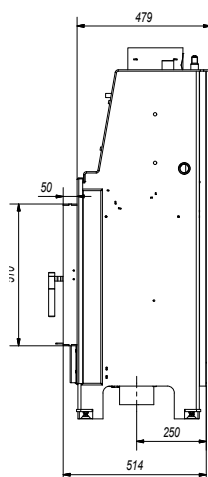
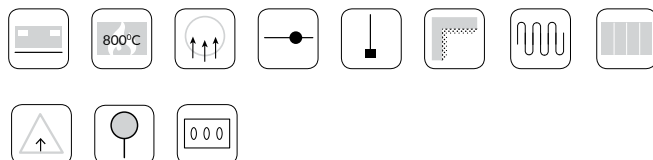

MBZ/PW/13/W



MBZ/PW/13/L/BS/W



MBZ/PW/13/P/BS/W



MBZ/PW/13/G/W

# MBO PW 15



kW	<kW<	kW $\Delta$		CO	bar
15	6-18	8	~83%	0,10%	2
PM				EEI	
7	210	306	200	109,30	42

Wyposażenie/Equipment/Ausstattung/Оборудование/  
 Vybavení/Equipement/Εξοπλισμός/Attrezzatura/Equipamiento:

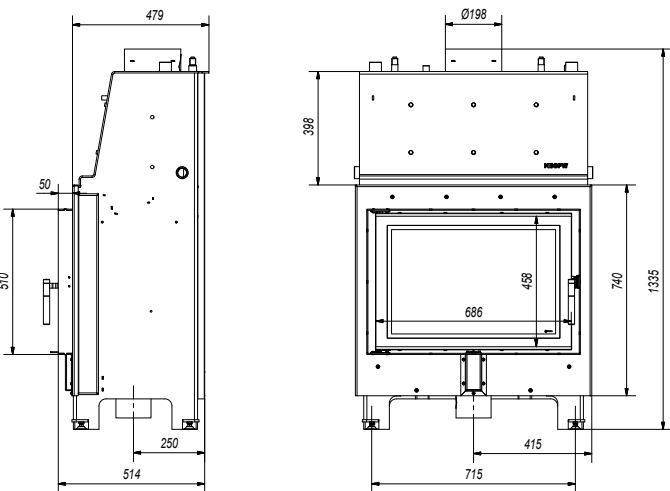
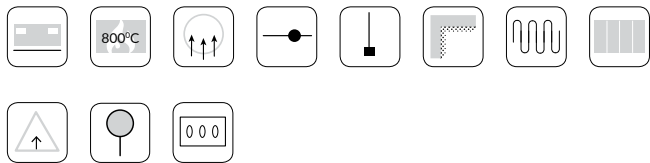

MBO/PW/15/W



MBO/PW/15/L/BS/W



MBO/PW/15/P/BS/W



MBO/PW/15/G/W



MBO PW 15

# MBA PW 17



kW	<kW<	kW0		CO	bar
17	9-19,5	9	~86%	0,09%	2
PM				EEI	
8	201	314,5	200	113,2	47

Wyposażenie/Equipment/Ausstattung/Оборудование/  
 Vybavení/Equipement/Εξοπλισμός/Attrezzatura/Equipamiento:

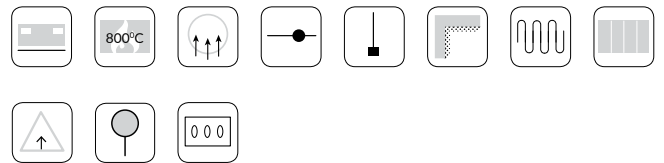

MBA/PW/17/L/BS/W



MBA/PW/17/P/BS/W



MBA/PW/17/G/W

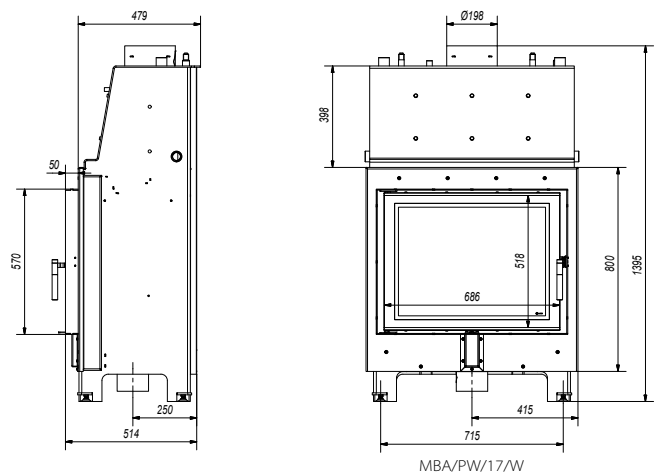

# LUCY PW 12



kW	<kW<	kW <sub>0</sub>		CO	bar
12	5-15	7	~82%	0,10%	2

PM				EEI	
24	210	215	200	108,01	35

Wyposażenie/Equipment/Ausstattung/Оборудование/  
 Vybavení/Equipement/Εξοπλισμός/Attrezzatura/Equipamiento:

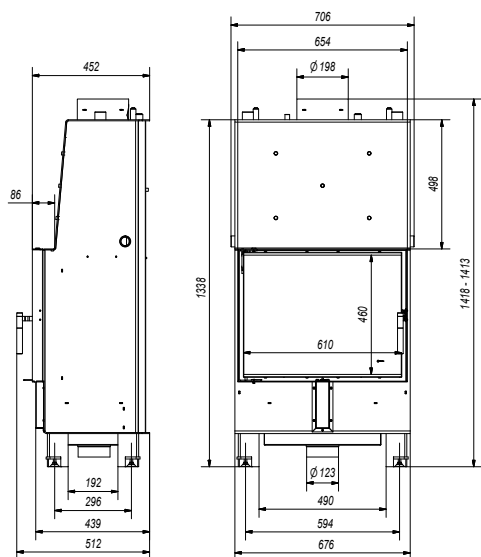
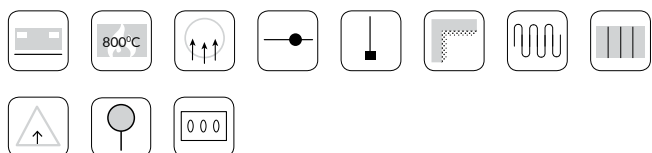

LUCY/PW/12/W

# LUCY PW 16



kW	<kW<	kW <sub>0</sub>		CO	bar
16	7-19	10	~84%	0,09%	2

PM				EEI	
25	200	257	200	110,62	39

Wyposażenie/Equipment/Ausstattung/Оборудование/  
 Vybavení/Equipement/Εξοπλισμός/Attrezzatura/Equipamiento:

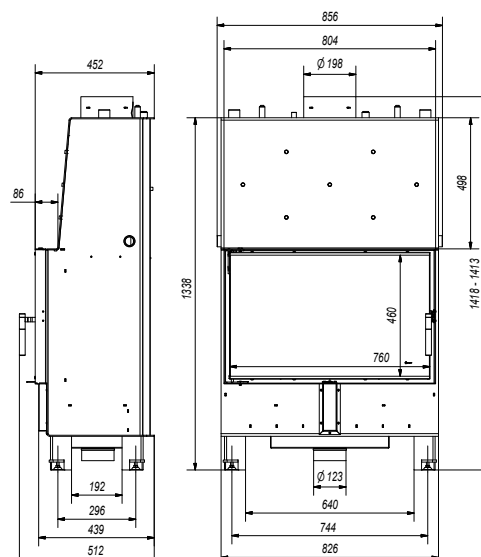
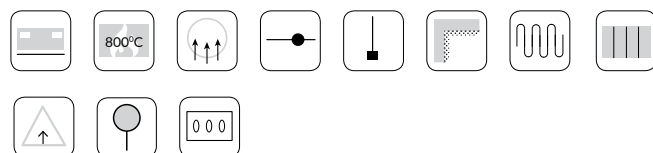

LUCY/PW/16/W

# LUCY PW 20



kW	<kW<	kW <sub>0</sub>		CO	bar
20	9-24	13	~82%	0,09%	2

PM				EEI	
22	230	293	200	108,01	45,5

Wyposażenie/Equipment/Ausstattung/Оборудование/  
 Vybavení/Equipement/Εξοπλισμός/Attrezzatura/Equipamiento:

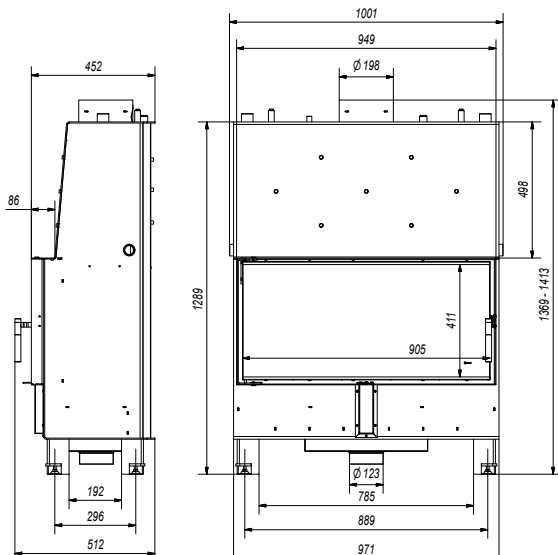
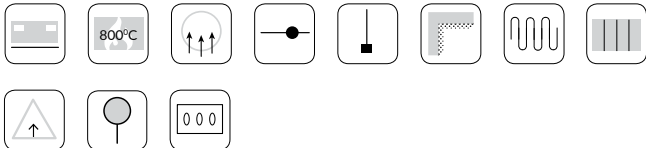

LUCY/PW/20/W



LUCY PW 12 W

# NADIA PW 10



kW	<kW<	kW <sub>0</sub>		CO	bar
12	5-13,5	4,7	~82%	0,10%	2

PM				EEI	
37	225	190	200	108,01	32

Wyposażenie/Equipment/Ausstattung/Оборудование/  
 Vybavení/Equipment/Εξοπλισμός/Attrezzatura/Equipamiento:

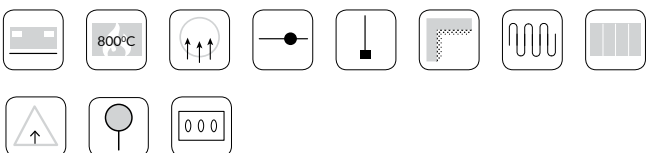

Dodatkové opcje/Additional options/Zusätzliche Optionen/  
 /Дополнительные опции/Dodatečné vybavení/Options supplémentaires/  
 Επιπλέον επιλογές/Opcioni aggiuntive/Opciones adicionales:

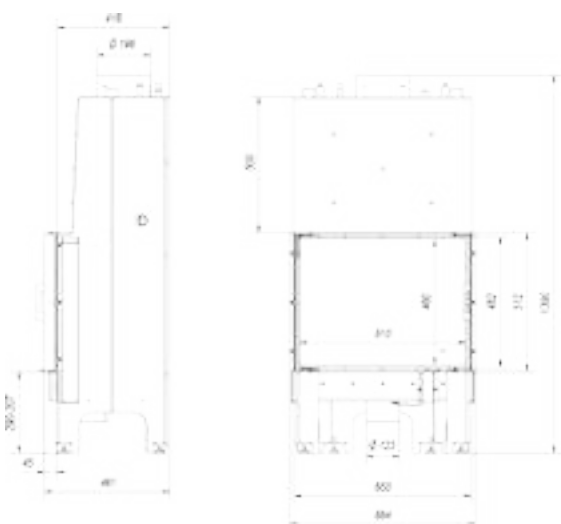
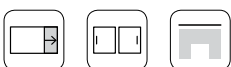

NADIA/PW10/W





MILA PW

## MILA PW



A

kW	<kW<	kW0		CO	bar
24	11-30	12	~78%	0,20%	2
PM		kg		EEI	
53,2	305	227	200	102,79	52

Wyposażenie/Equipment/Ausstattung/Оборудование/  
 Vybavení/Equipement/Εξοπλισμός/Attrezzatura/Equipamiento:

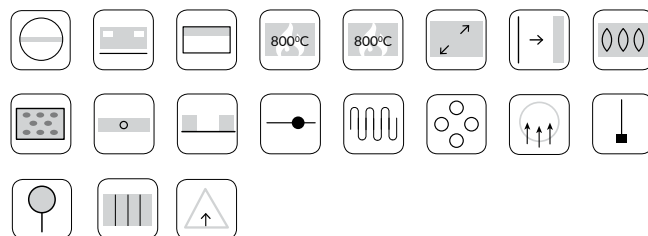

Dodatkové opcje/Additional options/Zusätzliche Optionen/  
 /Дополнительные опции/Dodatečné vybavení/Options supplémentaires/  
 Επιπλέον επιλογές/Opcioni aggiuntive/Opciones adicionales:



MILA/PW/24/G/W

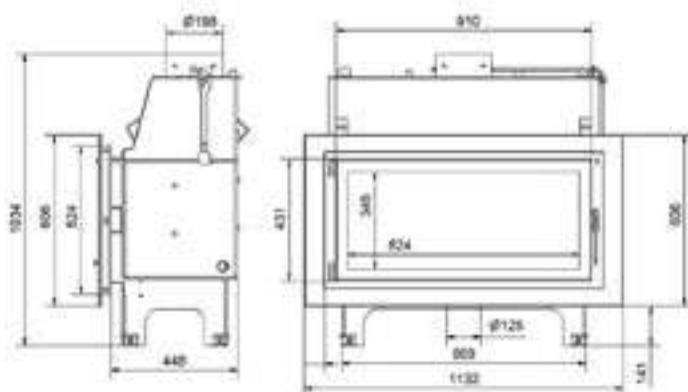

MILA/PW/24/W

# AQUARIO

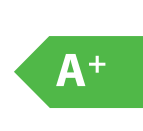

AQUARIO/M/8/PW/W



AQUARIO/M/12/PW/W



AQUARIO/Z/10/PW/W



AQUARIO/Z/14/PW/W

	<kW<	<kW<	kW0			CO	PM				GLASS	EEI
AQUARIO PW M 8	8	3.0 - 10.0	5,5	82	504x377	0,10	23	227	180	450	✓	108,0
AQUARIO PW M 12	12	5.0 - 15.0	8	86	504x377	0,09	26	185	180	450	✓	113,2
AQUARIO PW Z 10	10	4.0 - 13.0	7	82	559x401	0,10	13	205	200	550	✓	108,0
AQUARIO PW Z 14	14	6.0 - 17.0	10	83	559x401	0,08	9	235	200	550	✓	109,3
AQUARIO PW O 12	12	5.0 - 15.0	8,5	84	645x401	0,08	13	215	200	550	✓	110,6
AQUARIO PW O 16	16	7.0 - 19.0	9	82	645x401	0,10	11	215	200	550	✓	108,0
AQUARIO PW A 14	14	7.0 - 18.0	10	80	645x491	0,10	15	220	200	500	✓	105,4
AQUARIO PW A 18	18	8.0 - 21.0	12,5	84	645x491	0,09	33	210	200	500	✓	110,6

Wyposażenie/Equipment/Ausstattung/Оборудование/ Vybavení/  
 Equipement/Εξοπλισμός/Attrezzatura/Equipamiento:







AQUARIO/O/12/PW/W



AQUARIO/O/16/PW/W



AQUARIO/A/14/PW/W



AQUARIO/A/18/PW/W



# ANTEK PW



kW	<kW<	kW0	~72%	CO	bar
8	4-10	7		0,69%	2

PM	°C	kg	180	EEI	17
116	240	103		94,96	

Wyposażenie/Equipment/Ausstattung/Оборудование/  
 Vybavení/Equipement/Εξοπλισμός/Attrezzatura/Equipamiento:

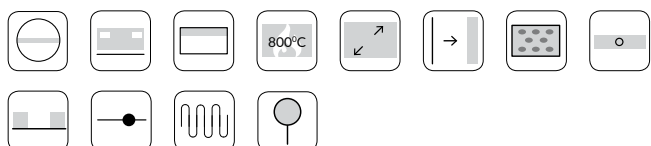

Dodatkové opcje/Additional options/Zusätzliche Optionen/  
 /Дополнительные опции/Dodatečné vybavení/Options supplémentaires/  
 Επιπλέον επιλογές/Opcioni aggiuntive/Opciones adicionales:

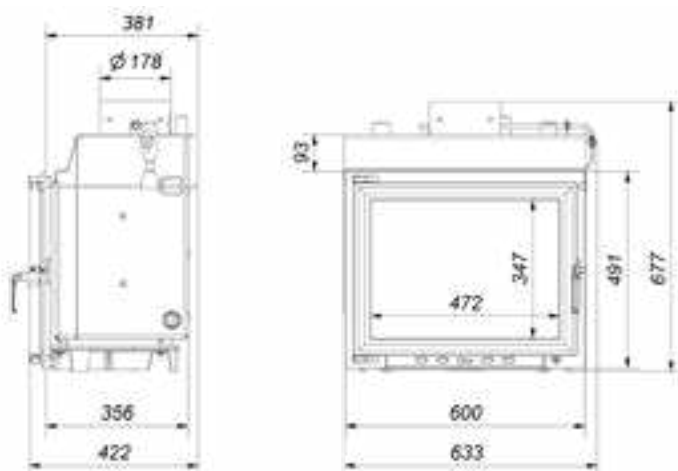

ANTEK/PW/8/W



ANTEK/PW/8/W/DECO



ANTEK/PW/8/G/W



ANTEK PW

## ERYK PW



A

kW 10	<kW< 5-13	kW0 9	~72%	CO 0,69%	bar 2
PM 116	°C 240	kg 110	180	EEl 94,96	17

Wyposażenie/Equipment/Ausstattung/Оборудование/  
Vybavení/Equipement/Εξοπλισμός/Attrezzatura/Equipamiento:

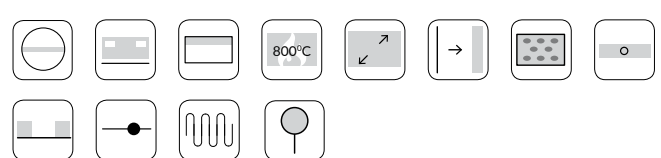

Dodatkowe opcje/Additional options/Zusätzliche Optionen:  
/Дополнительные опции/Dodatečné vybavení/Options supplémentaires/  
Επιπλέον επιλογές/Opzioni aggiuntive/Opciones adicionales:

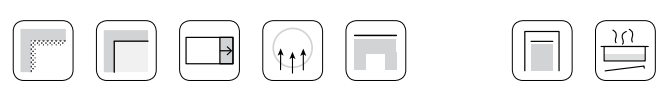

ERYK/PW/10/W/DECO



ERYK/PW/10/W/G

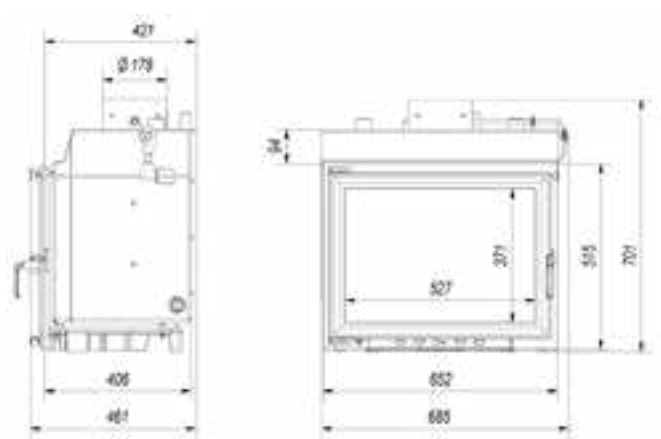

ERYK/PW/10/W

# MAJA PW



A+

kW	<kW<	kW $\Delta$		CO	bar
8	3,5-10	6	~80%	0,29%	2
PM				EEI	
31	240	109	180	107	18

Wyposażenie/Equipment/Ausstattung/Оборудование/  
 Vybavení/Equipment/Εξοπλισμός/Attrezzatura/Equipamiento:

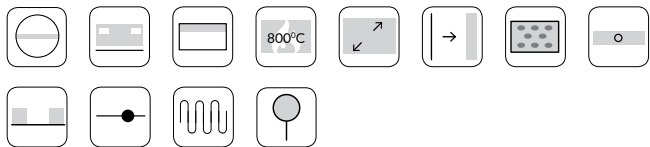

Dodatkové opcje/Additional options/Zusätzliche Optionen/  
 /Дополнительные опции/Dodatečné vybavení/Options supplémentaires/  
 Επιπλέον επιλογές/Opcioni aggiuntive/Opciones adicionales:

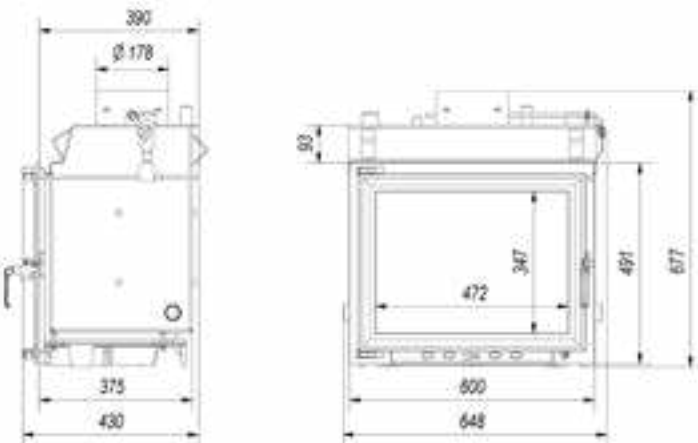

MAJA/PW/12/W



MAJA/PW/12/W/DECO



MAJA/PW/BL/12/W



MAJA/PW/BP/12/W



MAJA PW



MAJA/PW/BL/12/BS/W



OLIVIA/PW/BP/17/BS/W



MAJA/PW/BL/12/BS/W/DECO



MAJA/PW/BP/12/BS/W/DECO



MAJA/PW/12/G/W

# WIKTOR PW



A

<b>kW</b> 12	<b>&lt;kW&lt;</b> 6-15	<b>kW<math>\oslash</math></b> 8	 ~72%	<b>CO</b> 0,69%	<b>bar</b> 2
<b>PM</b> 116	 240	 129	 200	<b>EEl</b> 94,96	 17

Wyposażenie/Equipment/Ausstattung/Оборудование/  
 Vybavení/Equipement/Εξοπλισμός/Attrezzatura/Equipamiento:

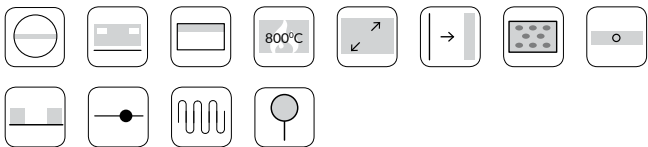

Dodatkové opcje/Additional options/Zusätzliche Optionen:  
 /Дополнительные опции/Dodatečné vybavení/Options supplémentaires/  
 Επιπλέον επιλογές/Opczioni aggiuntive/Opciones adicionales:

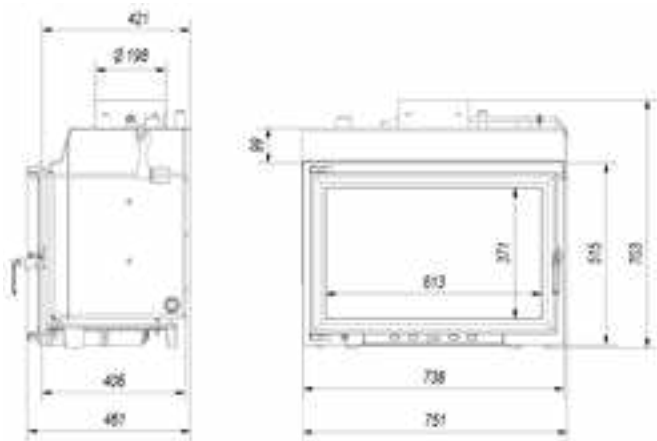
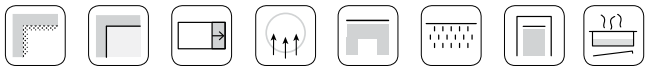

WIKTOR/PW/12/W



WIKTOR/PW/12/W/DECO



WIKTOR/PW/12/W/G



FELIX PW

## FELIX PW



A

kW	<kW<	kW0		CO	bar
13	7-17	11	~71%	0,31%	2
PM		kg		EEI	
116	322	139	200	93,66	17

Wyposażenie/Equipment/Ausstattung/Оборудование/  
 Vybavení/Equipement/Εξοπλισμός/Attrezzatura/Equipamiento:

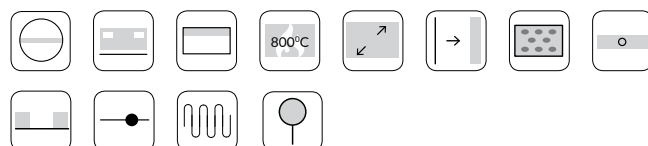

Dodatkowe opcje/Additional options/Zusätzliche Optionen:  
 /Дополнительные опции/Dodatečné vybavení/Options supplémentaires/  
 Επιπλέον επιλογές/Opcioni aggiuntive/Opciones adicionales:



FELIX/PW/14/W/DECO



FELIX/PW/14/G/W

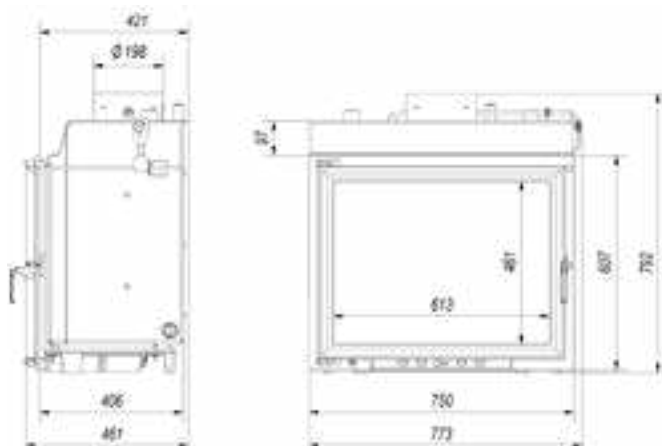

FELIX/PW/14/W

# ZUZIA PW



A+

A

<b>kW</b>	<b>&lt;kW&lt;</b>	<b>kW<sub>0</sub></b>		<b>CO</b>	<b>bar</b>
12 19	5-15 10-24	8 15	~81% ~75%	0,09% 0,26%	2 2
<b>PM</b>	<b>°C</b>	<b>kg</b>		<b>EEl</b>	
33 79,8	255 295	160 166	200 200	108,50 98,88	38 40,5

Wyposażenie/Equipment/Ausstattung/Оборудование/  
 Vybavení/Equipement/Εξοπλισμός/Attrezzatura/Equipamiento:

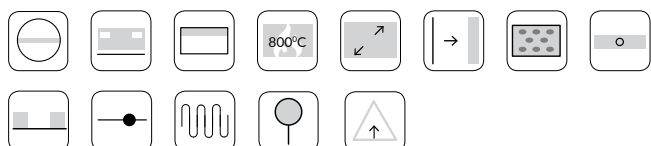

Dodatkové opcje/Additional options/Zusätzliche Optionen/  
 /Дополнительные опции/Dodatečné vybavení/Options supplémentaires/  
 Επιπλέον επιλογές/Opcioni aggiuntive/Opciones adicionales:

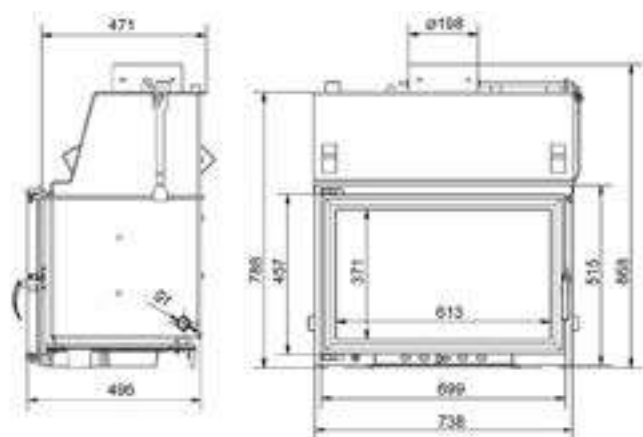

ZUZIA/PW/15/W  
 ZUZIA/PW/19/W







ZUZIA PW



ZUZIA/PW/15/W/DECO  
ZUZIA/PW/19/W/DECO



ZUZIA/PW/BL/15/W  
ZUZIA/PW/BL/19/W



ZUZIA/PW/BP/15/W  
ZUZIA/PW/BP/19/W



ZUZIA/PW/BL/15/BS/W  
ZUZIA/PW/BL/19/BS/W



ZUZIA/PW/BP/15/BS/W  
ZUZIA/PW/BP/19/BS/W



ZUZIA/PW/BL/15/BS/W/DECO  
ZUZIA/PW/BL/19/BS/W/DECO



ZUZIA/PW/BP/15/BS/W/DECO  
ZUZIA/PW/BP/19/BS/W/DECO



ZUZIA/PW/15/G/W  
ZUZIA/PW/19/G/W



ZUZIA/T/PW/19/W



OLIVIA/PW/17/W/DECO  
OLIVIA/PW/22/W/DECO



OLIVIA/PW/BL/17/W  
OLIVIA/PW/BL/22/W



OLIVIA/PW/BP/17/W  
OLIVIA/PW/BP/22/W



OLIVIA/PW/BL/17/BS/W  
OLIVIA/PW/BL/22/BS/W



OLIVIA/PW/BP/17/BS/W  
OLIVIA/PW/BP/22/BS/W



OLIVIA/PW/17/G/W  
OLIVIA/PW/22/G/W



OLIVIA/PW/BL/17/BS/W/DECO  
OLIVIA/PW/BL/22/BS/W/DECO



OLIVIA/PW/BP/17/BS/W/DECO  
OLIVIA/PW/BP/22/BS/W/DECO



OLIWIA DECO PW

## OLIWIA PW



A

kW	<kW<	kW <sub>0</sub>		CO	bar
17 22	8-23 11-29	13 18	~75% ~75%	0,28% 0,25%	2 2
PM				EEI	
44,2 60,9	305 390	178 182	200 200	98,88 98,88	35 46,5

Wyposażenie/Equipment/Ausstattung/Оборудование/  
Vybavení/Equipement/Εξοπλισμός/Attrezzatura/Equipamiento:

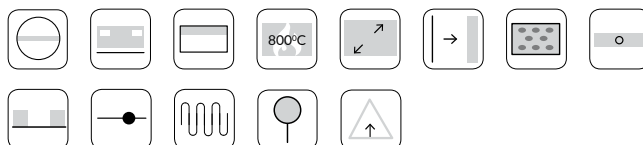

Dodatkowe opcje/Additional options/Zusätzliche Optionen:  
/Дополнительные опции/Dodatečné vybavení/Options supplémentaires/Επιπλέον επιλογές/Opzioni aggiuntive/ Opciones adicionales:

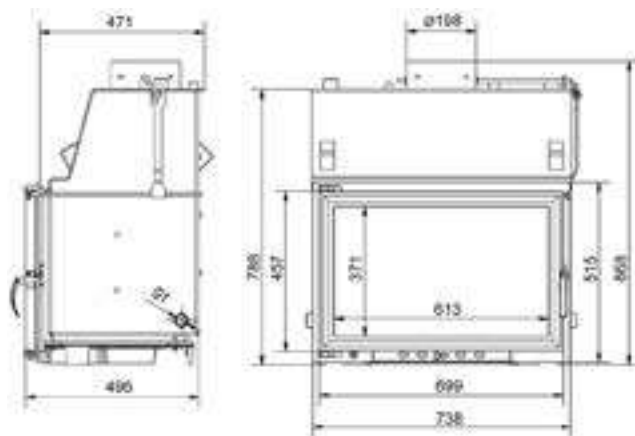

OLIWIA/PW/17/W  
OLIWIA/PW/22/W



AMELIA/PW/24/W/DECO  
AMELIA/PW/30/W/DECO



AMELIA/PW/BL/24/W  
AMELIA/PW/BL/30/W



AMELIA/PW/BP/24/W  
AMELIA/PW/BP/30/W



AMELIA/PW/BL/24/BS/W  
AMELIA/PW/BL/30/BS/W



AMELIA/PW/BP/24/BS/W



AMELIA/PW/BL/24/BS/W/DECO



AMELIA/PW/BP/24/BS/W/DECO



AMELIA/PW/24/G/W  
AMELIA/PW/30/G/W



AMELIA PW

## AMELIA PW

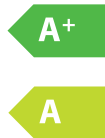

<b>kW</b>	<b>&lt;kW&lt;</b>	<b>kW<sub>0</sub></b>		<b>CO</b>	<b>bar</b>
24 28	11-30 13-35	20 24	~78% ~75%	0,30% 0,30%	2 2
<b>PM</b>	<b>°C</b>	<b>kg</b>		<b>EEI</b>	
98,4 100,5	290 300	195 201	220 220	102,79 98,88	57 60

Wyposażenie/Equipment/Ausstattung/Оборудование/  
Vybavení/Equipement/Εξοπλισμός/Attrezzatura/Equipamiento:

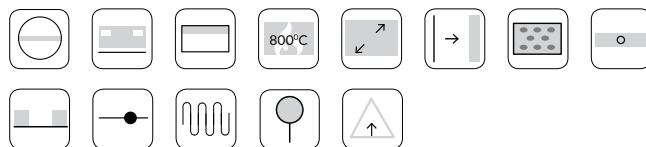

Dodatkové opcje/Additional options/Zusätzliche Optionen:  
/Дополнительные опции/Dodatečné vybavení/Options supplémentaires/Επιπλέον επιλογές/Opzioni aggiuntive/ Opciones adicionales:

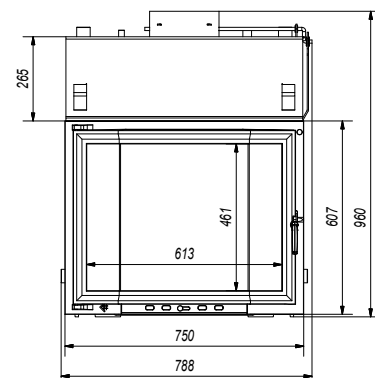
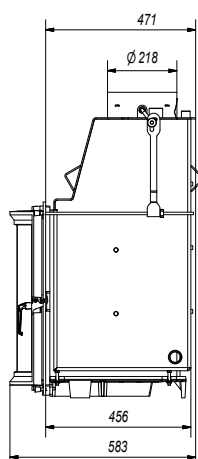

AMELIA/PW/24/W  
AMELIA/PW/30/W

# FRANEK PW



A+

kW	<kW<	kW $\circ$		CO	bar
12	5-15	6,5	~81%	0,10%	2

PM				EEI	
13	230	348	200	108,50	32

Wyposażenie/Equipment/Ausstattung/Оборудование/  
 Vybavení/Equipement/Εξοπλισμός/Attrezzatura/Equipamiento:

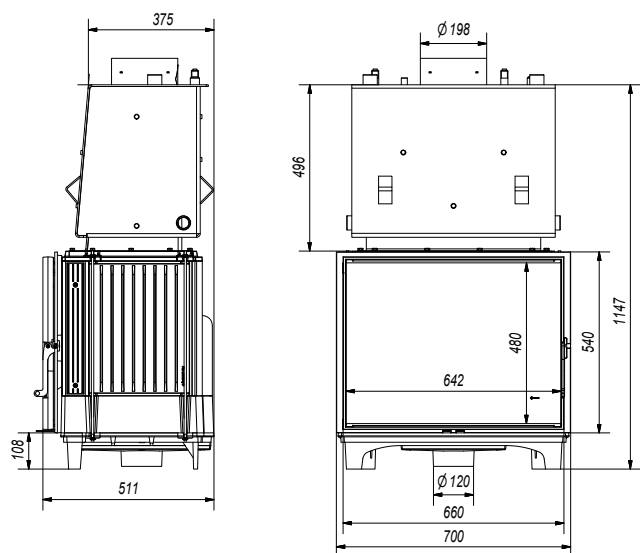
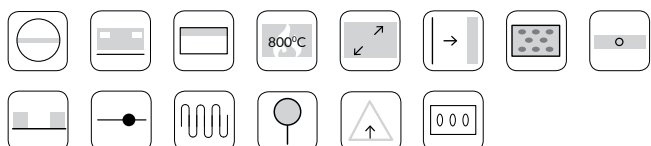















FRANEK/PW/12/W





FRANEK PW

															
MBM PW 10	12	5.0 - 14.0	7	85	0,10	27	111,9	185	26,5	180	2	A+	✓	✓	✓
MBZ PW 13	13	6.0 - 16.0	7	81	0,10	32	106,71	230	35	200	2	A	✓	✓	✓
MBO PW 15	15	6.0 - 18.0	8	83	0,10	7	109,30	210	42	200	2	A+	✓	✓	✓
MBA PW 17	17	9.0 - 19.5	9	86	0,09	8	113,20	201	47	200	2	A+	✓	✓	✓
Lucy PW 12	12	5.0 - 15.0	7	82	0,10	24	108,01	210	35	200	2	A+	✓	✓	✓
Lucy PW 16	16	7.0 - 19.0	10	84	0,09	25	110,62	200	39	200	2	A+	✓	✓	✓
Lucy PW 20	20	9.0 - 24.0	13	82	0,09	22	108,01	230	45,5	200	2	A+	✓	✓	✓
Nadia PW 10	12	5.0 - 13.5	4,7	82	0,10	37	108,01	225	32	200	2	A	✓	✓	✓
Mila PW 24	24	11.0 - 30.0	12	78	0,20	53,2	102,79	305	52	200	2	A			
AQUARIO PW M 8	8	3.0 - 10.0	5,5	82	0,10	23	108,0	227	37	180	2	A+	✓	✓	✓
AQUARIO PW M 12	12	5.0 - 15.0	8,0	86	0,09	26	113,2	185	47	180	2	A+	✓	✓	✓
AQUARIO PW Z 10	10	4.0 - 13.0	7,0	82	0,10	13	108,0	205	52	200	2	A+	✓	✓	✓
AQUARIO PW Z 14	14	6.0 - 17.0	10,0	83	0,08	9	109,3	235	83	200	2	A+	✓	✓	✓
AQUARIO PW O12	12	5.0 - 15.0	8,5	84	0,08	13	110,6	215	58	200	2	A+	✓	✓	✓
AQUARIO PW O 16	16	7.0 - 19.0	9	82	0,10	11	108,0	215	88	200	2	A+	✓	✓	✓
AQUARIO PW A 14	14	7.0 - 18.0	10	80	0,10	15	105,4	220	58	200	2	A	✓	✓	✓
AQUARIO PW A 18	18	8.0 - 21.0	12,5	84	0,09	33	110,6	210	88	200	2	A+	✓	✓	✓
ANTEK PW 8	8	4.0 - 10.0	7	72	0,69	116	94,96	240	17	180	2	A			✓
ERYK PW 10	10	5.0 - 13.0	9	72	0,69	116	94,96	240	17	180	2	A			✓
MAJA PW 12	8	3.5 - 10.0	6	80	0,10	31	107	240	18	180	2	A+	✓		✓
WIKTOR PW 12	12	6.0 - 15.0	8	72	0,69	116	94,96	240	17	200	2	A			✓
FELIX PW 13	13	7.0 - 17.0	11	71	0,31	116	93,66	322	17	200	2	A			✓
ZUZIA PW 15	12	5.0 - 15.0	8	81	0,09	33	108,50	255	38	200	2	A+			✓
ZUZIA PW 19	19	10.0 - 24.0	15	75	0,26	79,8	98,88	295	40,5	200	2	A			✓
OLIWIJA PW 17	17	8.0 - 23.0	13	75	0,28	44,2	98,88	305	35	200	2	A			✓
OLIWIJA PW 22	22	11.0 - 29.0	18	75	0,25	60,9	98,88	390	46,5	200	2	A			✓
AMELIA PW 24	24	11.0 - 30.0	20	78	0,30	98,4	102,79	290	57	220	2	A+			✓
AMELIA PW 30	28	13.0 - 35.0	24	75	0,30	100,5	98,88	300	60	220	2	A			✓
FRANEK PW 12	12	5.0 - 15.0	6,5	81	0,10	13	108,50	230	32	200	2	A+	✓	✓	✓



232	50	535x396	✓	✓	✓		✓				✓			✓	✓			✓
262	50	584x458	✓	✓	✓		✓				✓			✓	✓			✓
306	50	686x458	✓	✓	✓		✓				✓			✓	✓			✓
314,5	50	686-518	✓	✓	✓		✓				✓			✓	✓			✓
215	50	607x477	✓								✓		✓		✓	✓	✓	✓
257	50	757x477	✓								✓		✓		✓	✓	✓	✓
293	50	902x428	✓								✓		✓		✓	✓	✓	✓
190	35	607x477	✓								✓			✓	✓		✓	✓
227	700	824-345	✓				✓											
195	45	504x377	✓								✓		✓		✓			
210	45	504x377	✓								✓		✓		✓			
249	55	559x401	✓								✓		✓		✓			
283	55	559x401	✓								✓		✓		✓			
275	55	645x401	✓								✓		✓		✓			
305	55	645x401	✓								✓		✓		✓			
293	50	645x491	✓								✓		✓		✓			
328	50	645x491	✓								✓		✓		✓			
103	33	489x368	✓	✓		✓	✓	✓			✓	✓				✓		
110	45	544x393	✓	✓		✓	✓	✓			✓	✓				✓		
109	33	472x347	✓	✓	✓	✓	✓	✓	✓	✓	✓	✓				✓		
129	45	630x393	✓	✓		✓	✓	✓			✓	✓				✓		
139	45	634x485	✓	✓		✓	✓	✓			✓	✓				✓		
160	50	527x371	✓	✓	✓	✓	✓	✓	✓	✓	✓	✓				✓		
166	50	527x371	✓	✓	✓	✓	✓	✓	✓	✓	✓	✓				✓		
178	50	630x393	✓	✓	✓	✓	✓	✓	✓	✓	✓	✓				✓		
182	50	630x393	✓	✓	✓	✓	✓	✓	✓	✓	✓	✓				✓		
195	50	613x461	✓	✓	✓	✓	✓	✓	✓	✓	✓	✓				✓		
201	50	613x461	✓	✓		✓	✓	✓			✓	✓				✓		
348	50	642x480	✓								✓				✓	✓		✓



Gaz odniesienia / Gas Type / Bezugsgas / Газ отнесения / Referenční plyn / Gaz de référence / Αέριο αναφοράς / Tipo di gas



Kategoria urządzenia / Category / Kategorie der Anlage / Категория оборудования / Kategorie zařízení / Catégorie de l'appareil / Κατηγορία συσκευής / Categoria



Kraj przeznaczenia / Country / Bestimmungsland / Страна предназначения / Cílové země / Pays de destination / Χώρες προορισμού / Nazione / País



Nominalne ciśnienia przyłączeniowe / Nominal inlet pressure / Anschlussnennndruck / Номинальное соединительное давление / Nominální připojovací tlak připojení / Pression nominale de raccordement / Ονομαστική τιμή πίεσης σύνδεσης / Pressione di ingresso nominale / Presión nominal de entrada



Maksymalne ciśnienia przyłączeniowe / Max. inlet pressure / Maximaler Anschlussdruck / Максимальное соединительное давление / Maximální tlak připojení / Pression maximale de raccordement / Μέγιστη πίεση σύνδεσης / Massima pressione di connessione / Presión máxima de conexión



Minimalne ciśnienia przyłączeniowe / Min. inlet pressure / Minimaler Anschlussdruck / Минимальное давление подключения / Minimální připojovací tlak připojení / Pression minimale de raccordement / Ελάχιστη τιμή πίεσης σύνδεσης / Pressione minima di connessione / Presión mínima de conexión



Dysza gazowa palnika głównego / Gas jet of main burner / Gasdüse des Hauptbrenners / Сопло главной горелки / Plynová tryska hlavního hořáku / Buse de gaz du brûleur principal / Ακροφύσιο αερίου κεντρικού καυστήρα / Getto di gas del bruciatore principale / Llama piloto del quemador principal



Dysza gazowa palnika pilota / Gas jet of pilot burner / Gasdüse des Kontrollbrenners / Обозначение сопла / Plynová tryska hořáku dálkového ovladače / Buse de gaz du brûleur de la télécommande / Ακροφύσιο αερίου καυστήρα πιλότου / Getto di gas del bruciatore pilota / Chorro de gas del quemador piloto



Dysza gazowa Oznaczenie / Marking gas nozzle / Düsenkennzeichnung / Обозначение сопла / Označení trysky hlavního hořáku / Désignation de la buse du brûleur principal / Ονομασία ακροφυσίου κεντρικού καυστήρα / Ugello del gas di marcatura / Designación de la boquilla del gas



Obciążenie cieplne znamionowe, wg H<sub>i</sub> / Nominal heat load, wg H<sub>i</sub> / Nennwärmebelastung nach H<sub>i</sub> / Номинальная тепловая нагрузка / Jmenovitě tepelné zatížení, podle H<sub>i</sub> / Charge thermique nominale selon H<sub>i</sub> / Ονομαστικό θερμικό φορτίο, H<sub>i</sub> / Carico termico nominale, H<sub>i</sub>



Obciążenie cieplne minimalne, wg H<sub>i</sub> / Minimum heat load, wg H<sub>i</sub> / Minimale Wärmebelastung nach H<sub>i</sub> / Минимальная тепловая нагрузка / snížené tepelné zatížení, podle H<sub>i</sub> / Charge thermique réduite selon H<sub>i</sub> / Μειωμένο θερμικό φορτίο, H<sub>i</sub> / Carico termico minimo, H<sub>i</sub>



Klasa sprawności urządzenia / Efficiency class devices / Leistungsklasse der Anlage / Класс / Třída účinnosti zařízení / Classe de performance de l'appareil / Κλάση απόδοσης συσκευής / Dispositivi di classe di efficienza / Clase de eficiencia del dispositivo



# KOZA AB S GAZ

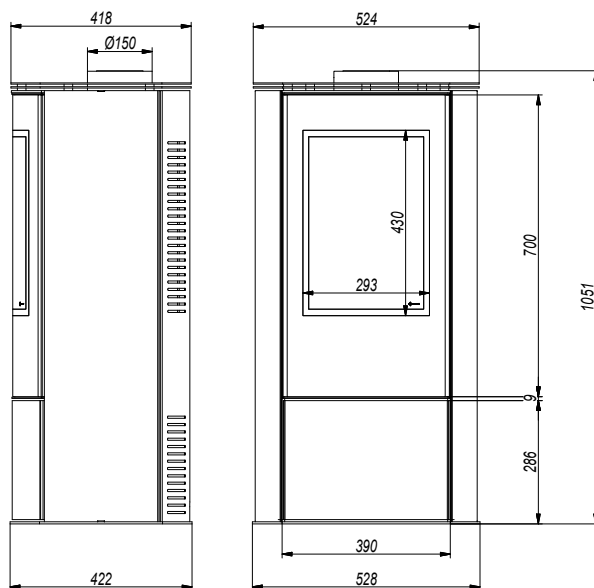

# LEO 45/68 HOME EASY BOX

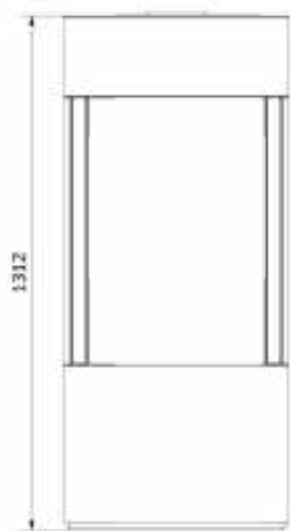

LEO/HOME/BOX/LP/45/68

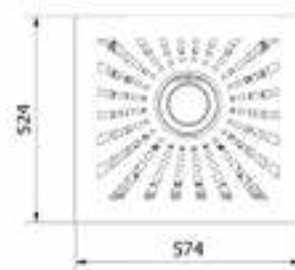



# LEO 45



LEO/45/68/G31/37MBar  
LEO/45/68/G20



	-	G20	G25.3	G30			G31		
	-	$I_{2E,2H}$	$I_{EK}$	$I_{3B/P}$			$I_{3P}$		
	-	AT, BE, CH, CY, CZ, DE, DK, EE, ES, FI, FR, GB, GR, HR, IE, IT, LT, LU, LV, NO, PL, PT, RO, SE, SI, SK, TR	NL	BE, CY, DK, EE, FR, GB, GR, HU, HR, IT, LT, NL, NO, RO, SE, SI, SK, TR	PL	AT, CH, DE, SK, GR	FI, NL, RO	BE, CH, CZ, ES, FR, GB, GR, HR, IE, IT, LT, NL, PL, PT, SI, SK	
		20	25	30	37	50	30	37	50
	mbar	25	30	35	45	57,5	35	45	57,5
		17	20	20	25	42,5	20	25	42,5
	mm	1,9	1,9	1,2			1,2		
		5,8	5,5	4,1			3,8		
		3,7	3,6	3,1			2,9		

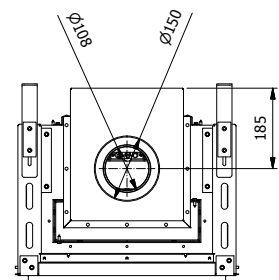
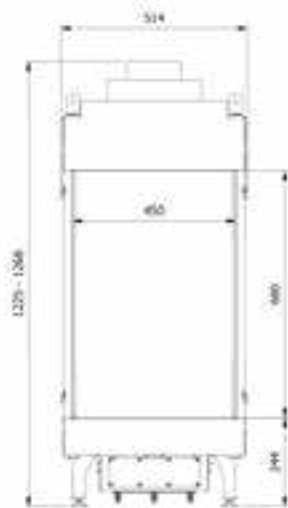

LEO/L/45/68/G20  
LEO/L/45/68/G31/37MBar



LEO/P/45/68/G20  
LEO/P/45/68/G31/37MBar



LEO/LP/45/68/G20  
LEO/LP/45/68/G31/37MBar





LEO/70/G20  
LEO/70/G31/37M BAR



	-	G20	G25	G25.3	G30	G30	G31	G31
	-	I <sub>2E+2H</sub> , I <sub>2E+</sub>	I <sub>2E+</sub>	I <sub>EK</sub>	I <sub>3B/P</sub>	I <sub>3B/P</sub>	I <sub>3P</sub>	I <sub>3P</sub>
	-	AT, BE, CH, CY, CZ, DE, DK, EE, ES, FI, FR, GB, GR, HR, IE, IT, LT, LU, LV, NO, PL, PT, RO, SE, SI, SK, TR	BE, FR	NL	BE, CH, CY, CZ, DE, DK, EE, ES, FR, GR, HU, HR, IE, IT, LT, NL, NO, PT, RO, SE, SI, SK, TR	AT, CH, DE, GR, SK	FI, NL, RO	BE, CH, CY, CZ, ES, FR, GB, GR, IE, LT, HR, IT, NL, PL, PT, SI, SK, TR
		20	25	30	50	30	37	
	mbar	Reg. zab.	Reg. zab.	29	29	22,9	22,9	
		5,5	6,8	8,0	8,0	6,5	6,5	
		2,1	2,1	1,3	1,3	1,3	1,3	
	mm	2 x ø 0,25	2 x ø 0,25	ø 0,25	ø 0,25	ø 0,25	ø 0,25	
		7,3	6,8	6,1		4,8		
	kW	3,5						

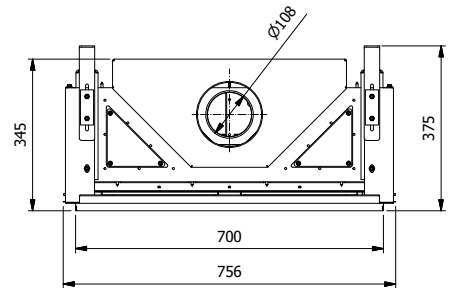
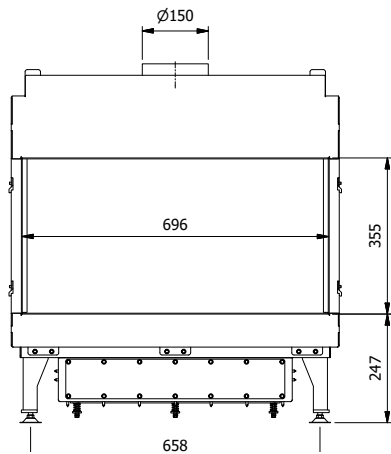
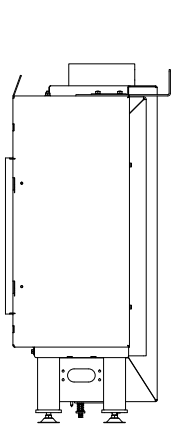

LEO/L/70/G20  
LEO/L/70/G31/37M BAR



LEO/P/70/G20  
LEO/P/70/G31/37M BAR



LEO/LP/70/G20  
LEO/LP/70/G31/37M BAR



# LEO 76



LEO/76/62/G20  
LEO/76/62/G31/37MBar



	-	G20	G25.3	G30			G31		
	-	$l_{2E/2H}$	$l_{EK}$	$l_{3B/P}$			$l_{3P}$		
	-	AT, BE, CH, CY, CZ, DE, DK, EE, ES, FI, FR, GB, GR, HR, IE, IT, LT, LU, LV, NO, PL, PT, RO, SE, SI, SK, TR	NL	BE, CY, DK, EE, FR, GB, GR, HU, HR, IT, LT, NL, NO, RO, SE, SI, SK, TR	PL	AT, CH, DE, SK, GR	FI, NL, RO	BE, CH, CZ, ES, FR, GB, GR, HR, IE, IT, LT, NL, PL, PT, SI, SK	
		20	25	30	37	50	30	37	50
	mbar	25	30	35	45	57,5	35	45	57,5
		17	20	20	25	42,5	20	25	42,5
	mm	1,9	2,3	1,3			1,3		
		8,6	8,0	5,6			5,1		
	kW	5,2	4,9	4,4			5,1		

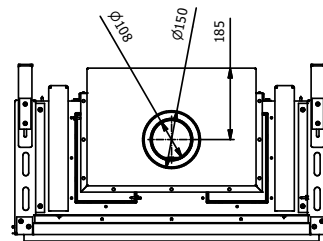
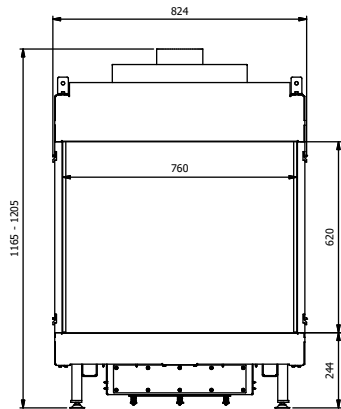
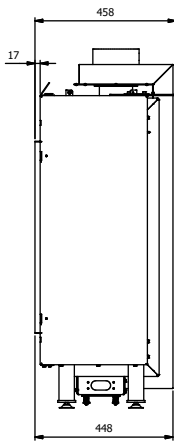

LEO/L/76/62/G20  
LEO/L/76/62/G31/37MBar



LEO/P/76/62/G20  
LEO/P/76/62/G31/37MBar



LEO/LP/76/62/G20  
LEO/LP/76/62/G31/37MBar

# LEO 100



LEO/100/G20  
LEO/100/G31/37MBAR



LEO/LP/100/TUNEL/NG  
LEO/LP/100/TUNEL/LPG



LEO/100/TUNEL/NG  
LEO/100/TUNEL/LPG



LEO/L/100/G20  
LEO/L/100/G31/37MBAR



LEO/P/100/G20  
LEO/P/100/G31/37MBAR



LEO/LP/100/G31/37MBAR  
LEO/LP/100/G20

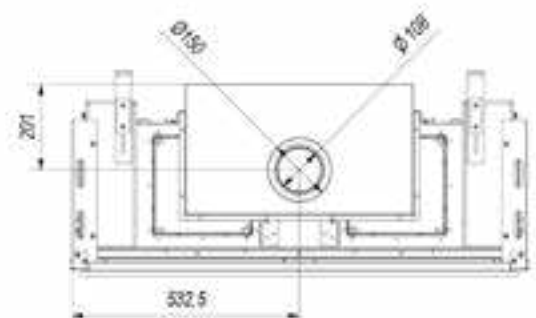
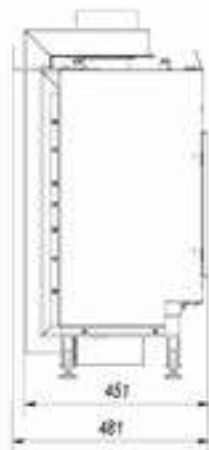
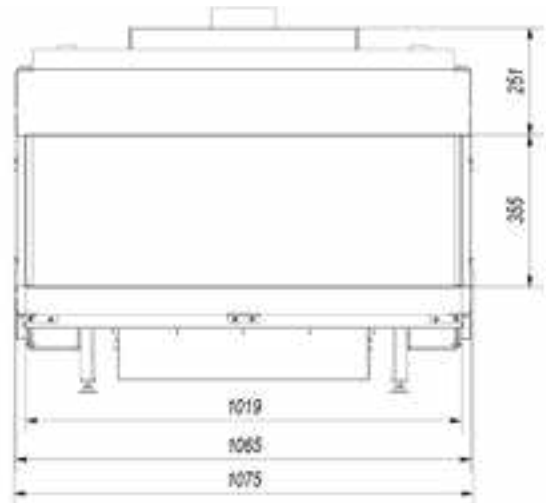
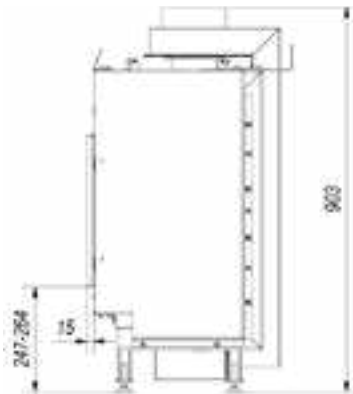



LEO/200/G20  
LEO/200/G31/37MBAR



LEO/L/200/G20  
LEO/L/200/G31/37MBAR



LEO/P/200/G20  
LEO/P/200/G31/37MBAR



LEO/LP/200/G31/37MBAR  
LEO/LP/200/G20

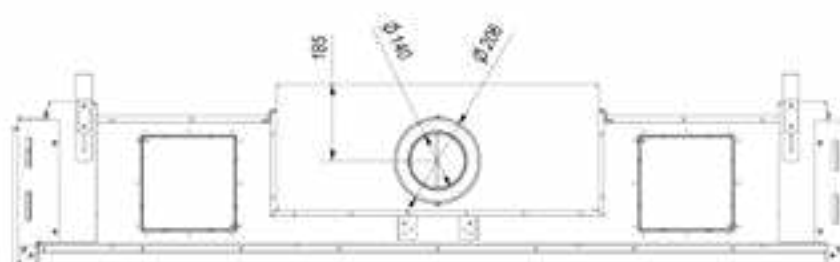
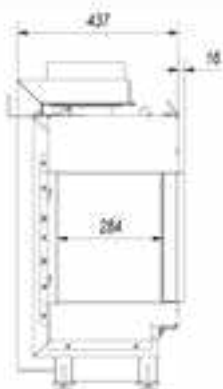
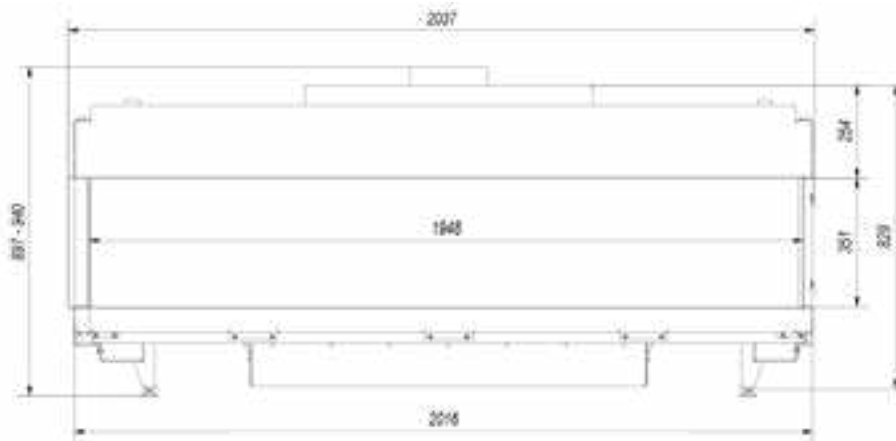

# PATIO / PATIO MINI

NEW

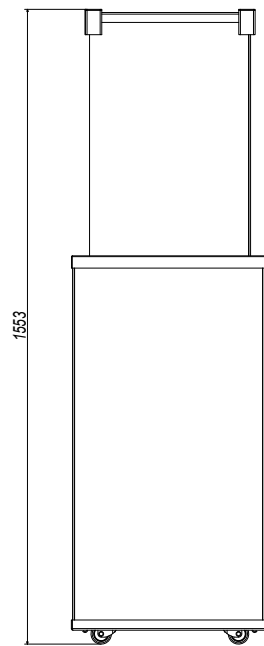
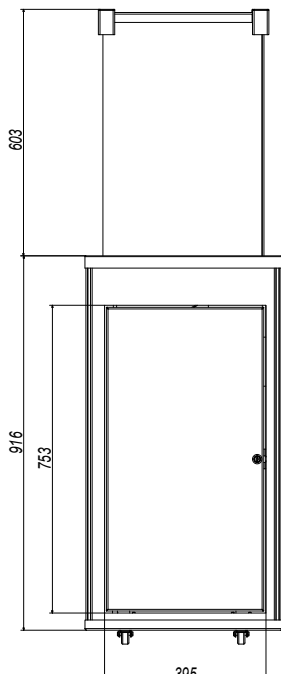

PATIO

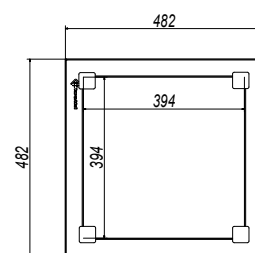



Calce Antracite

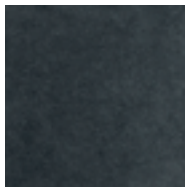

Blend Nero

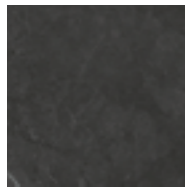

Naturali Pietra  
Grey Bocciardata



Seta Liquorice



Nero Assoluto



Oxide Nero



Filo Oro



Filo Argento



Filo Ghisa

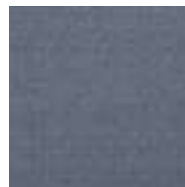

Filo Mercurio

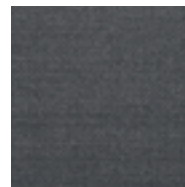

Filo Pece



Oxide Moro

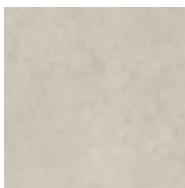

Fokos Sale



Naturali Ossidiana  
Vena Chiara



Naturali Ossidiana  
Vena Grigia



Oxide Grigio



Naturali Pietra  
Di Savoia Grigia

PL / Wzory i kolory materiałów wykończeniowych przedstawionych w katalogu mogą różnić się od rzeczywistych kolorów.  
 EN / Patterns and colours of finishing materials presented in the catalogue may differ from actual colours.  
 DE / Muster und Farben der im Katalog vorgestellten Veredelungsmaterialien können von den tatsächlichen Farben abweichen.  
 RU / Представленные в каталоге узоры и цвета отделочных материалов могут отличаться от реальных цветов.  
 CZ / Vzory a barvy dokončovacích materiálů uvedené v katalogu se mohou lišit od skutečných barev.  
 FR / Les motifs et les couleurs des matériaux de finition présentés dans le catalogue peuvent différer des couleurs réelles.  
 GR / Τα σχέδια και τα χρώματα των υλικών φινιρίσματος που παρουσιάζονται στον κατάλογο ενδέχεται να διαφέρουν από τα πραγματικά χρώματα.  
 IT / I motivi e i colori dei materiali di finitura presentati nel catalogo possono differire dai colori reali.  
 ES / Los patrones y colores de los materiales de acabado presentados en el catálogo pueden diferir de los colores reales.

# UMBRELLA

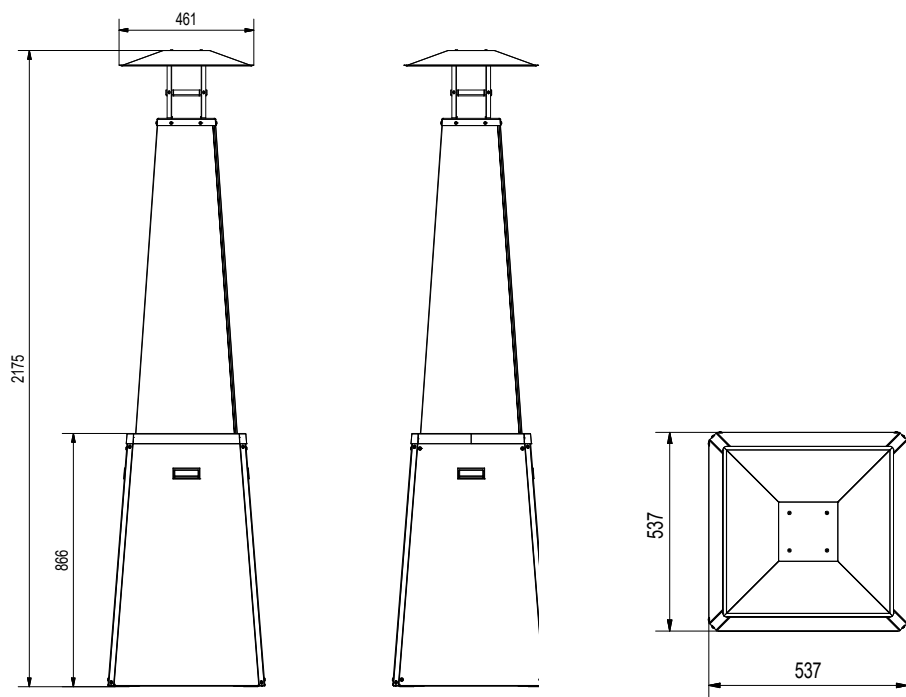

UMBRELLA



	LEO 100						LEO 200						PATIO na pilota / PATIO remote control					
	-	G20	G25	G30		G31		G20	G25	G30		G31		G31	G31	G31	G30	G30
	-	┌ <sub>2E'</sub> ┐┌ <sub>2H</sub> ┐┌ <sub>2E+</sub> ┐	┌ <sub>2L</sub> ┐┌ <sub>2E+</sub> ┐	┌ <sub>3B/P</sub> ┐┌ <sub>3+</sub> ┐	┌ <sub>3B/P</sub> ┐	┌ <sub>3B/P</sub> ┐┌ <sub>3+</sub> ┐	┌ <sub>2E'</sub> ┐┌ <sub>2H</sub> ┐┌ <sub>2E+</sub> ┐	┌ <sub>2L</sub> ┐┌ <sub>2E+</sub> ┐	┌ <sub>3B/P</sub> ┐┌ <sub>3+</sub> ┐	┌ <sub>3B/P</sub> ┐	┌ <sub>3B/P</sub> ┐	┌ <sub>3B/P</sub> ┐┌ <sub>3+</sub> ┐	┌ <sub>3P(30)</sub> ┐	┌ <sub>3P(37)</sub> ┐	┌ <sub>3P(50)</sub> ┐	┌ <sub>3B/P(30)</sub> ┐	┌ <sub>3B/P(37)</sub> ┐	
	-	AT, BE, CH, CY, CZ, DE, DK, EE, ES, FI, FR, GB, GR, HR, IE, IT, LT, LU, LV, NO, PL, PT, RO, SE, SI, SK, TR	BE, FR, NL	BE, CH, CY, CZ, DE, DK, EE, ES, FR, GR, HU, HR, IE, IT, LT, NL, NO, PT, RO, SE, SI, SK, TR	AT, CH, DE, GR, SK	FI, NL, RO	BE, CH, CY, CZ, DE, DK, EE, ES, FR, GB, GR, IE, LT, HR, IT, NL, PL, PT, SI, SK, TR	AT, BE, CH, CY, CZ, DE, DK, EE, ES, FI, FR, GB, GR, HR, IE, IT, LT, LU, LV, NO, PL, PT, RO, SE, SI, SK, TR	BE, FR, NL	BE, CH, CY, CZ, DE, DK, EE, ES, FR, GR, HU, HR, IE, IT, LT, NL, NO, PT, RO, SE, SI, SK, TR	AT, CH, DE, GR, SK	FI, NL, RO	BE, CH, CY, CZ, DE, DK, EE, ES, FR, GB, GR, IE, LT, HR, IT, NL, PL, PT, SI, SK, TR	FI, NL, RO	BE, CH, CY, CZ, DE, DK, EE, ES, FR, GB, GR, IE, IT, LT, HR, NL, PL, PT, SI, SK	AT, CH, DE, NL	BE, CY, CZ, DK, EE, ES, FR, GB, GR, HU, IE, IT, LT, NL, NO, PT, RO, SE, SI, SK	PL
		20	25	30	50	30	37	20	25	30	50	30	37	30	37	50	30	37
	mbar	25	30	35	57,5	35	45	25	30	35	57,5	35	45	23,0	23,0	23,0	17,0	17,0
		17	20	20	42,5	25	25	17	20	20	42,5	25	25	6,0	6,0	6,0	4,5	4,5
		2,6	2,6	1,65	1,65	1,70	1,65	2,45	2,45	1,60	1,60	1,70	1,60	-	-	-	-	-
	mm	2 x Ø 0,25	2 x Ø 0,25	Ø 0,25	Ø 0,25	Ø 0,25	Ø 0,25	2 x Ø 0,25	2 x Ø 0,25	Ø 0,25	Ø 0,25	Ø 0,25	Ø 0,25	-	-	-	-	-
	-	NG 26	NG 26	LPG165	LPG165	LPG17	LPG165	NG 245	NG 245	LPG16	LPG16	LPG17	LPG16	1,65 LPG 1.65				
		10,0	10,0	9,2	9,2	9,2	9,2	17,0					8,2	8,2	8,2	8,2	8,2	
	kW	4,3	4,3	4,3	4,3	4,3	4,3	8,5					4,0	4,0	4,0	4,0	4,0	
	%	2						2										

\* Regulator zablokowany / Regulator Blocked / Regler gesperrt / Заблокированный регулятор / Regulátor bloková / Régulateur bloqué / Ρυθμιστής μπλοκαρισμένος / Regolatore bloccato / Regulador bloqueado

\*\* Śruba regulacyjna całkowicie rozkręcona / Adjusting screw completely unscrewed / Einstellschraube vollständig abgeschraubt / Регулировочный винт полностью отвинчен / Nastavovací šroub je zcela odšroubován / Vis de réglage complètement dévissée / Η βίδα ρύθμισης έχει ξεβιδωθεί πλήρως / Vite di regolazione completamente svitata / Tornillo de ajuste completamente desenroscado





			PATIO							KOZA AB S gaz									
G30	G30/G31	G31	G31	G31	G30	G30	G30	G30/G31	G20	G25	G20/G25	G30			G31			G30/G31	
I <sub>3B/P(50)</sub>	I <sub>3+(30/37)</sub>	I <sub>3P(30)</sub>	I <sub>3P(37)</sub>	I <sub>3P(50)</sub>	I <sub>3B/P(30)</sub>	I <sub>3B/P(37)</sub>	I <sub>3B/P(50)</sub>	I <sub>3+(30/37)</sub>	I <sub>2E(20)/I<sub>2H(20)</sub></sub>	I <sub>2L(25)</sub>	I <sub>2E+(20/25)</sub>	I <sub>3B/P(30)</sub>	I <sub>3B/P(37)</sub>	I <sub>3B/P(50)</sub>	I <sub>3P(30)</sub>	I <sub>3P(37)</sub>	I <sub>3P(50)</sub>	I <sub>3+(30/37)</sub>	
AT, CH, DE, FR, SK	BE, CH, CY, CZ, ES, FR, GB, GR, IE, IT, LT, HR, NL, PL, PT, SI, SK	FI, NL, RO	BE, CH, CY, CZ, ES, FR, GB, GR, IE, IT, LT, HR, NL, PL, PT, SI, SK	AT, CH, DE, NL	BE, CY, CZ, DK, EE, ES, FR, GB, GR, HU, IE, IT, LT, NL, NO, PT, RO, SE, SI, SK	PL	AT, CH, DE, FR, SK	BE, CH, CY, CZ, ES, FR, GB, GR, IE, IT, LT, HR, NL, PL, PT, SI, SK	AT, CH, CY, CZ, DK, EE, ES, FI, GB, GR, HR, IE, IT, LT, LU, LV, NO, PT, RO, SE, SI, SK, TR, HU, DE, PL, RO	NL	BE, FR	BE, CY, DK, EE, FR, GB, GR, HU, HR, IT, LT, NL, NO, RO, SE, SI, SK, TR	PL	AT, CH, DE, FR, SK	FI, NL, RO	BE, CH, CZ, ES, FR, GB, GR, HR, IE, IT, LT, NL, PL, PT, SI, SK	AT, CH, DE, NL, SK	BE, CH, CY, CZ, ES, FR, GB, GR, IE, IT, LT, PT, SI, SK, TR	
50	30/37	30	37	50	30	37	50	30/37	20	25	20/25	30	37	50	30	37	50	30/37	
17,0	*	23,0	23,0	23,0	17,0	17,0	17,0	**	25	30	25/30	35	45	57,5	35	45	57,5	35/45	
4,5	7,0/9,0	7,5	8,0	6,5	5,5	7,0	5,5	12,0/14,0	17	20	17/20	25	25	45	25	25	45	25	
-	-	-	-	-	-	-	-	-	1,90	1,90	1,90	1,20			1,30			1,15	
-	-	-	-	-	-	-	-	-	2 x Ø 0,25	2 x Ø 0,25	2 x Ø 0,25	Ø 0,25	Ø 0,25	Ø 0,25	Ø 0,25	Ø 0,25	Ø 0,25	2 x Ø 0,25	
	1,45 LPG 1.45	1,65 LPG 1.65							1,45 LPG 1.45	NG1.9	NG1.9	NG1.9	LPG1.2			LPG1.3			LPG1.15
8,2	8,2	8,2	8,2	8,2	8,2	8,2	8,2	8,2	5,2	5,2	5,2	4,5			4,5			4,4	
4,0	4,0	4,9	4,9	4,9	4,9	4,9	4,9	4,9	2,7	2,7	2,7	2,3			2,3			2,7	
									2										



## Palenisko gazowe AQF

Gas furnace AQF / Gasofen AQF / Газовая печь AQF / Plynová pec AQF /  
Fournaise à gaz AQF / Φούρνος αερίου AQF / Forno a gas AQF / Horno de gas AQF



	kW	<kW<	kg	mm
AQF 01	11,5	3.7 - 11.5	25	39,5x39,5
AQF 02	11,5	3.7 - 11.5	25	47,1 x39,5
AQF 03	11,5	3.7 - 11.5	25	48,7 x 48,7
AQF 04	11,5	3.7 - 11.5	11	60,1 x 39,5
AQF 05	11,5	3.7 - 11.5	13,5	60,1 x 48,7
AQF 06	11,5	3.7 - 11.5	25	73,1 x 39,5
AQF 07	11,5	3.7 - 11.5	25	73,1 x 48,7



AQF/02/SIERRA/G30/37MBAR/ZESTAW





Wszystkie projekty,  
które tworzymy powstają z myślą  
o potrzebach naszych Klientów...

„All of the projects created by us meet the needs of our customers..”

„Alle Projekte, die wir erstellen, entstehen mit dem Gedanken an Bedürfnisse unserer Kunden..”

„Все проекты мы создаём с мыслью об удовлетворении потребностей наших клиентов..”

„Všetchny projekty, které tvoříme, vznikají se snahou splnit potřeby našich zákazníků..”

„Tous nos projets sont créés pour répondre aux besoins de nos clients..”

„Όλες οι εκτελέσεις μας, δημιουργούνται με τρόπο και με βάση τις ανάγκες των πελατών μας..”

„Stiamo creando tutti i progetti pensando alle esigenze dei nostri Clienti..”

„Creamos nuestros proyectos pensando en las necesidades de nuestros clientes..”





# HOME EASY BOX / SIMPLE BOX



## HOME EASY BOX stalowy

Kominek HOME EASY BOX to połączenie nowoczesnego i ekologicznego wkładu NBC 7 oraz gotowej zabudowy ze stali w kolorze czarnym. Całość stanowi idealną odpowiedź na obecne trendy w architekturze wnętrz. Doskonałe proporcje oraz minimalizm w połączeniu z trójstronną wizją ognia stworzą przytulny klimat, który sprzyja bezproblemowym rodzinnym spotkaniom.

## HOME EASY BOX steel casing

The HOME EASY BOX fireplace is a combination of a modern and ecological NBC 7 insert and ready-made black steel casing. It is the perfect answer to current trends in interior architecture. Perfect proportions and minimalism combined with a tri-sided vision of fire will create a cozy atmosphere.

kW 7	<kW< 3-9	 ~83%	 160	CO 0,10%
PM 29	 199	 188	 680x339	EEI 105,40

HOME EASY BOX



kW 8	<kW< 3-10	 ~80%	 200	CO 0,10%
PM 25	 238	 115	 563x347	EEI 105,40



SIMPLE BOX

# BLANKA KAFEL



≥ 700 cm<sup>2</sup>  
≥ 500 cm<sup>2</sup>



**kW** 8    **<kW<** 7,5-11    ~78%    160    **CO** 0,10%

**PM** 36    285 °C    247 kg    344x406    **EEl** 102,79

Wyposażenie/Equipment/Ausstattung/Оборудование/  
Vybavení/Equipement/Εξοπλισμός/Attrezzatura/Equipamiento:

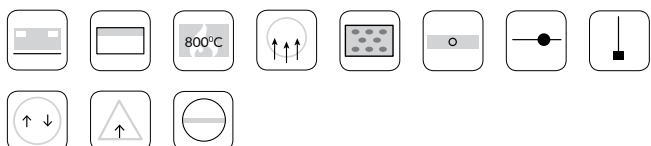

BLANKA/KAFEL/C  
BLANKA/KAFEL/K

# NADIA KAFEL B RYFEL NADIA MILANO



≥ 900 cm<sup>2</sup>  
≥ 700 cm<sup>2</sup>



**kW** 7    **<kW<** 3-9    ~80%    200    **CO** 0,10%

**PM** 38    245 °C    274 kg    452x512    **EEl** 105,04

Wyposażenie/Equipment/Ausstattung/Оборудование/  
Vybavení/Equipement/Εξοπλισμός/Attrezzatura/Equipamiento:



Dodatkowe opcje/Additional options/Zusätzliche Optionen:  
/Дополнительные опции/Dodatečné vybavení/Options supplémentaires/Επιπλέον επιλογές/Opzioni aggiuntive/ Opciones adicionales:

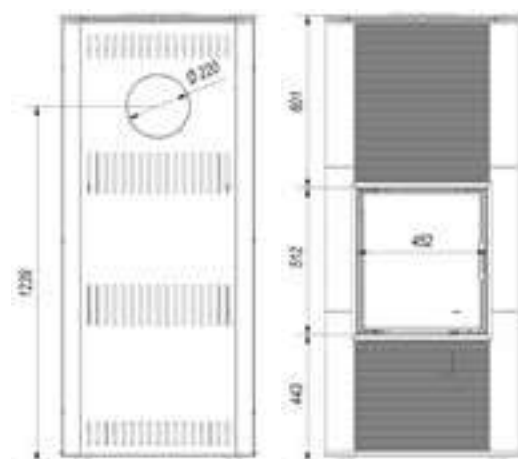
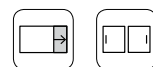

NADIA/KAFEL/B/RYFEL



# WK 440



A

<b>kW</b> 6,5	<b>&lt;kW&lt;</b> 3-9,3	~80%	130	<b>CO</b> 0,20%
<b>PM</b> 53	327	130	316x285	<b>EEI</b> 105,04

Wyposażenie/Equipment/Ausstattung/Оборудование/  
 Vybavení/Equipement/Εξοπλισμός/Attrezzatura/Equipamiento:

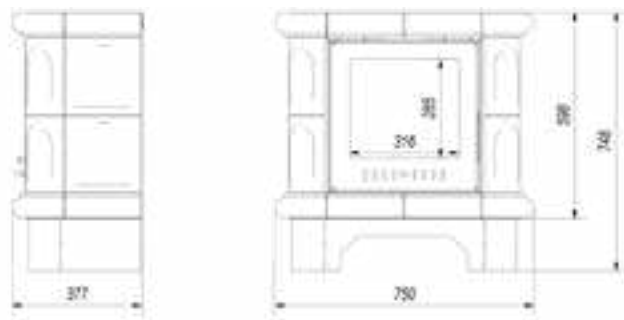

WK/440/KAFEL/CZ  
 WK/440/KAFEL/K

## WYPOSAŻENIE PIECÓW WOLNOSTOJĄCYCH

Advantages for freestanding stoves/Vorteile der freistehenden Öfen/Преимущества печи

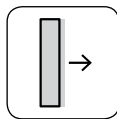

ASDP - automatyczne sterowanie dopływem powietrza do kóz to oparty na bimetalu, samoregulujący się termostat - dodatkowa opcja / ASDP - automatic control of air supply for the free standing stove is based on a bi-metal, self-regulating thermostat - additional option / ASDP - automatische Steuerung der Externluft bei den freistehenden Öfen, selbstregelnder Thermostat - zusätzliche Option / Автоматическое управление подачей воздуха в печь - саморегулируемый термостат - дополнительный выбор / Asdp (αίρν) - automatické řízení přívodu vzduchu do kamen na principu bimetalu, samočinně se regulující termostat / ASDP - commande automatique de l'entrée d'air neuf dans la chambre de combustion des poêles à bois, basée sur le bimétal (bilame); un thermostat autoregulant / Σύστημα αυτόματου ελέγχου εισαγωγής αέρα για τζακόσμπες, αυτόματος θερμοστάτης με βάση βιομεταλλομυνίου / ASDP - controllo automatico aria in ingresso al di fuori per la stufia, basato su un bi-metallico, auto-regolazioni del termostato / ASDP - mando automático de aire externo en estufa exenta, termostato auto-regulable - opción adicional



Szproszy - ażur ozdoby do pieców wolnostojących koza K6, K7 i K9 - dodatkowa opcja / Openwork decoration for stoves K6, K7 and K9 - additional option / Zierelemente des freistehenden Ofens k6, K7 und k9 - zusätzliche Option / Zierelemente des freistehenden Ofens k6, K7 und k9 - zusätzliche Option / Декор двери - декоративные элементы для печек K6, K7 и K9 - дополнительный выбор / Ozdobná mřížka - ozdobný prolamovaný vzor k volně stojícím kamnům Koza K6 a K9 / Ajour décoratif pour vitres - disponibles pour poêles à bois K6 et K9 / Διακοσμητικά στοιχεία για τζακόσμπες K6 και K9 / Decorativo ornamento in vetro per stufia a legno K6 e K9 / Marco decorativo para estufa K6, K7 y K9 - opción adicional



Deflektor - wydłuża drogę spalin / Deflector - extends the exhaust path / Deflektor - verlängert den Abgasweg / Встроенный дефлектордефлектор / Deflektor - prodlužující dráhu kouřových plynů / Déflecteur - allonge le trajet des fumées / Κόφτης, προκαλεί εκτροπή των καυσαερίων / Deflettore aumento percorso fum / Deflector - para alargar el circuito de humos



Ścianki paleniska o minimalnej grubości 8 mm gwarantują bezawaryjne działanie paleniska / Fireplace with a minimum wall thickness of 8 mm, guarantee a trouble-free operation of the fireplace / Wanddicke des Einsatzes 8mm garantiert einen störungsfreien Betrieb des Ofens / Минимальная толщина стенки 8 мм обеспечивают бесперебойной работу / Stěny ohniště s minimální tloušťkou 8 mm zaručí bezporuchovou funkci ohniště / Les parois d'épaisseur minimale de 8mm garantissent le fonctionnement optimal du foyer / Τοιχώματα εστίας πάχους 8μμ, εξασφαλίζουν άψογη λειτουργία / Paredi del forno uno spessore minimo di 8 mm garantire un funzionamento senza problemi del camino / Espesor de pared de 8 mm, para garantizar un buen funcionamiento de la chimenea

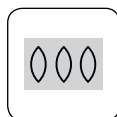

Ozdobna płyta tylna / Decorative back plate / Dekorative hintere Platte / Декоративная задняя плита / Dekorativní zadní deska / Paroi arrière décorative / Διακοσμητική πλάκα / Piastra dietro decorativo / Placa posterior decorativa

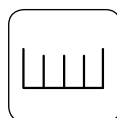

Koszyzek na węgiel do kozy K9 - dodatkowa opcja / Basket for carbon for stove k9 - additional option / Kohlebehälter für den Ofen k9 - zusätzliche Option / Корзина для угля Печь K9 - дополнительный выбор / Koš na uhlí pro kamna Koza 9 / Panier à charbon pour Poêle à bois KOZA K9 / Καλαθάκι για κάρβουνα για την τζακόσμπη KOZA K9 / Carrello del carbone per la stufia K9 / Carrello del carbone per la stufia K9 / Cesta para carbón para estufa K9 - opción adicional

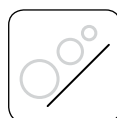

Fajerki - do kóz K6, K9 i K10 wraz z pogrzebaczem - dodatkowa opcja / Hot plates for Koza K6, K9, K10 along with poker - additional option / Ofenringe passend zu den Öfen K6, K9 und K10 zusammen mit dem Schürhaken - zusätzliche Option / Чугунные диски для печей K6, K9, K10 с держателем - дополнительный выбор / Varná plotýnka - ke kamnům Koza K6, K9 a K10 spolu s pohrabáčem / Ronds de poêle - disponibles pour poêles K6, K9 et K10 (avec rrique-feu) / Αφαιρούμενα μάτια για τζακόσμπες K6, K9 και K10 μαζί με ειδική τσιμπίδα / Per stufe K6, K9 e K10 - con elemento per spingere ceneri / Aros para estufas K6, K9 y K10 con gancho - opción adicional

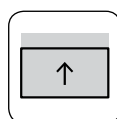

Turbina TURBOFAN, której zadaniem jest efektywniejsze rozprowadzenie ciepła wytwarzanego przez piec typu koza po pomieszczeniu, w którym pracuje - dodatkowa opcja / TURBOFAN efficiently distribute the heat produced by a free standing stove in the room, where it works - additional option / Die Turbine TURBOFAN, deren Aufgabe darin besteht, die vom Ofen erzeugte warme Luft in den Raum zu verteilen, die dem Ofen steht - zusätzliche Option / Турбина ТУРБОФАН задача которой - более эффективное распространение тепла отходящего от печи типа "Коza" по помещению, в котором она находится - дополнительный выбор / Turbina TURBOFAN, jejímž úkolem je efektivnější rozvod tepla vyvíjeného kamny typu „koza“ v místnosti, ve které kamna pracují / Turbine TURBOFAN dont le rôle est de distribuer l'air chaud plus efficacement dans la pièce où le poêle avec Turbofan se trouve / Τουρμπίνα TURBOFAN ανακυκλοφορίας του αέρα, η οποία αυξάνει την απόδοση της σόμπας. / Turbine TURBOFAN l'operazione che distribuzione efficiente aria calda prodotto dalla stufia tipo di Koza la stanza in cui lavorare / TURBOFAN - turbina para la extracción del aire caliente producido por la estufa - opción adicional

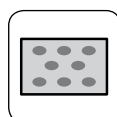

Ruchomy ruszt, dzięki któremu można łatwo wymieść popiół / Movable grate gives possibility of easily wipe away the ash / Beweglicher Rost hilft beim Reinigen / Движущиеся решетка благодаря которой Вы можете легко стереть пепел / Vymetelný rošt umožňující snadné vymetání popelu / Grille de suier amovible pour faciliter l'évacuation des cendres / Grille de foyer amovible pour faciliter l'évacuation des cendres / Αφαιρούμενη σχάρα, διευκολύνει τον καθαρισμό της εστίας / Griglia mobile, grazie alla quale può essere facilmente pulito cenere / Parrilla móvil para facilitar la limpieza de las cenizas

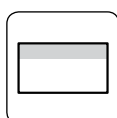

Kierownica powietrza tworząca system czystej szyby - ograniczający osadzanie się sadzy na szybie / Air clean glass-forming system - limits the deposition of soot on the glass / Luftmantel an derr Frontscheibe - verringert die Rußablagerung an der Scheibe / Управление воздухом, система чистого стекла / Přívod vzduchu na sklo po systém čistého skla - sloužící k zamezení usazování sazí na skleněné tabuli / Système „vitre propre“ par rideau d'air - atténue la suie sur la vitre / Αεροκροστίνα, αποτρέπει το μαύρισμα τζαμιού / Sterzo aria creazione sistema pulito vetri - limitativo sedimentazione nerofumo sul vetro / Sistema de limpieza del cristal - evita que se deposite hollín en el cristal

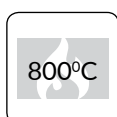

Ceramika żaroodporna wytrzymaująca temperaturę do 800°C / Heat-resistant ceramic can withstand temperatures up to 800°C / Hitzbeständige Keramikschleibe bis 800 Grad / Жароупорное стекло выдерживающие температуру до 800 градусов / Žáruvzdorné sklo odolné proti teplotě do 800°C / Vitre réfractaire supporte la température jusqu'à 800°C / Πυράντοχο τζάμι, έως 800°C / Vetro resistente al calore in grado di sopportare temperature fino a 800 gradi / Cristal resistente a temperatura de 800°C

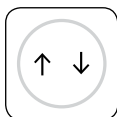

Możliwość zamieszczenia wylotu spalin na górze i z tyłu (oprócz modelu k8 tunnel) / Possibility to mount the exhaust outlet at the top and back (except model k8 tunnel) / Rohranschluss von oben und von hinten (ausser des Modell Koza k8) / Выпуск газов-возможность инсталляции из верха и в задней части печек (кроме печки K8 двухсторонной) / Možnost umístění ústí kouřových plynů nahoře i zezadu (kromě modelu k8 tunnel) / Possibilité de sortie des fumées: dessus ou arrière (sauf modèle K8 Tunnel) / Δυνατότητα τοποθέτησης καμινάδας στο πάνω ή στο πίσω μέρος / Possibilità installazione I gas di scarico e sopra e indietro (ma modello k8 tunnel) / Conexión para tubo superior y salida trasera (excepto modelo Koza K8)

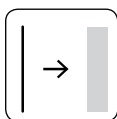

System zimnej klamki umożliwia zdjęcie klamki w momencie palenia w kominku / The system of cold handle allows to take it off during the combustion process / System des kalten Griffs ermöglicht während des Brennvorgangs den Griff abzunehmen / Система холодной ручки / Systém studené kliky umožňuje sundání kliky při topení v krbu / Système de poignée froide - possibilité d'enlever la poignée pendant la combustion dans le foyer / Αφαιρούμενο πόμολο κατά την διάρκεια λειτουργίας τζακιού, για να προστατεύεται από υπερθέρμανση / Il sistema la maniglia fredda è possibile rimuovere la maniglia al momento della combustione nel focolare / Maneta fría extraíble

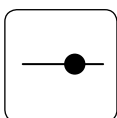

Regulacja dopływu powietrza do spalania / Regulation of air supply for combustion / Regulieren des Luftstroms durch die Aschenschublade / Регулирование притока воздуха через вынимаемый пеплосборник / Regulace přívodu vzduchu skrz popelník (primárního ke spalování) / Réglage d'arrivée d'air pour la combustion / Ρύθμιση εισαγωγής αέρα μέσω του σταχτοδοχείου (πρωτογενής καύσης) / Regolazione dell'aria primaria per la combustione / Regulación del suministro de aire para la combustión

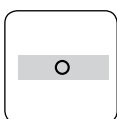

Szufłada/pojemnik na popiół, gdzie gromadzą się pozostałości po spalonym drewnie / Ash drawer/container where remains burnt wood / Aschenschublade in derer sich der Rest des verbrannten Holzes sammelt / Ящик/контейнер для пепла - здесь собираются остатки дров / Zásuvka na popel, ve které se shromažďují zbytky spáleného dříví / Tiroir à cendres sert à collecter les résidus de combustion / Συρτάρι στάχτης, διοχετεύει υλολείμματα μετά την καύση / Cassetto per cenere che si accumulano in resti di legno bruciato / Cajón cenicero - contenedor de brasas



\*Nóżki ozdobne / \*Decorative base feet / \*Verzierte Füße / \*Декоративные ножки / \*Dekorativní nožky / \*Jambes décoratives / \*Διακοσμητικά ποδαράκια / \*Piedini decorativo / \*Patas decorativas

# KOZA AB



8



5,5-10,5



~78%



150



0,08%



39



265



125



290x427



102,79

Wyposażenie/Equipment/Ausstattung/Оборудование/  
 Vybavení/Equipement/Εξοπλισμός/Attrezzatura/Equipamiento:

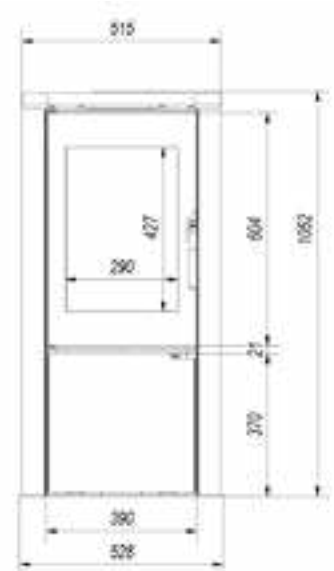

KOZA/AB

# KOZA AB S DR



<b>kW</b> 8	<b>&lt;kW&lt;</b> 5,5-10,5	 ~78%	 150	<b>CO</b> 0,08%
<b>PM</b> 39	 265	 110	 290x430	<b>EEI</b> 102,79

Wyposażenie/Equipment/Ausstattung/Оборудование/  
Vybavení/Equipement/Εξοπλισμός/Attrezzatura/Equipamiento:

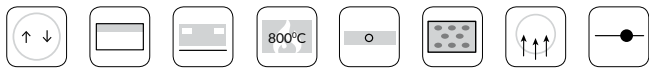

Dodatkowe opcje/Additional options/Zusätzliche Optionen:  
/Дополнительные опции/Dodatečné vybavení/Options supplémentaires/  
Επιπλέον επιλογές/Opcioni aggiuntive/ Opciones adicionales:

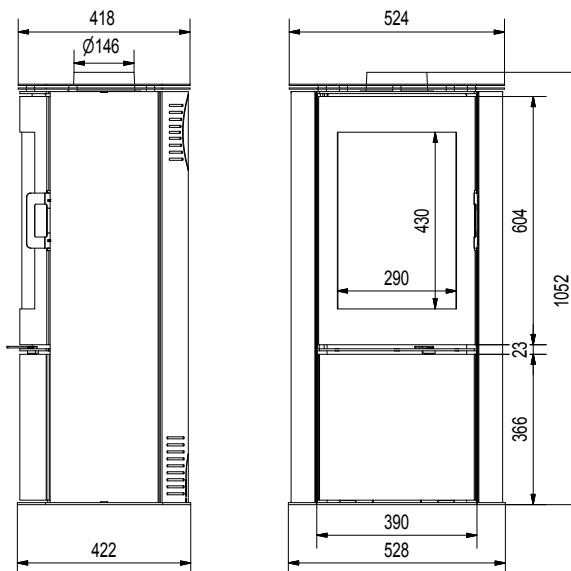

KOZA/AB/S/DR

# KOZA AB S 2



<b>kW</b> 10	<b>&lt;kW&lt;</b> 4-12	 ~80%	 150	<b>CO</b> 0,09%
<b>PM</b> 15	 280	 145	 540x430	<b>EEI</b> 105,40

Wyposażenie/Equipment/Ausstattung/Оборудование/  
Vybavení/Equipement/Εξοπλισμός/Attrezzatura/Equipamiento:

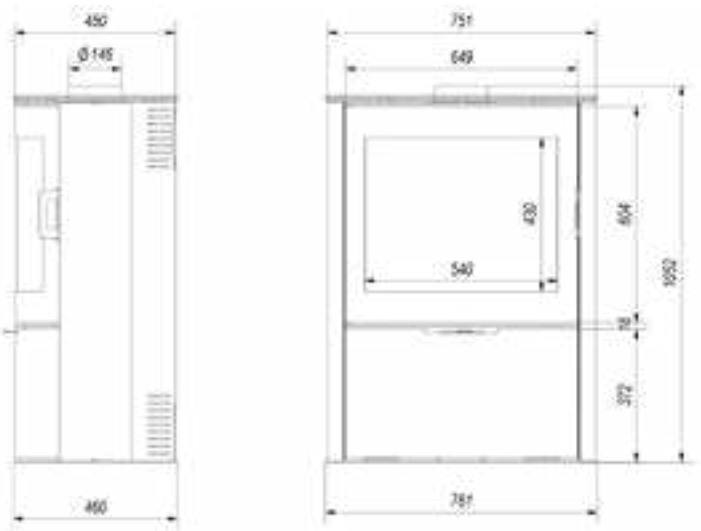
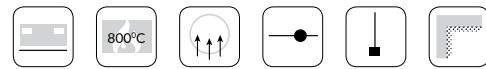

KOZA/AB/S/2

# KOZA AB S N DR



kW	<kW<			CO
8	5,5-10,5	~78%	150	0,08%

PM				EEl
39	265	108	290x427	102,79

Wyposażenie/Equipment/Ausstattung/Оборудование/  
Vybavení/Equipement/Εξοπλισμός/Attrezzatura/Equipamiento:



Dodatkové opcje/Additional options/Zusätzliche Optionen:  
/Дополнительные опции/Dodatečné vybavení/Options supplémentaires/Επιπλέον επιλογές/Opzioni aggiuntive/ Opciones adicionales:

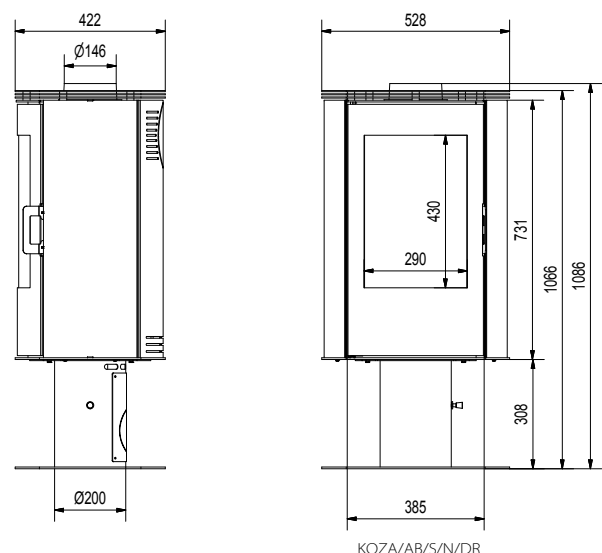

# KOZA AB S N O DR



kW	<kW<			CO
8	5,5-10,5	~78%	150	0,08%

PM				EEl
39	265	113	290x427	102,79

Wyposażenie/Equipment/Ausstattung/Оборудование/  
Vybavení/Equipement/Εξοπλισμός/Attrezzatura/Equipamiento:



Dodatkové opcje/Additional options/Zusätzliche Optionen:  
/Дополнительные опции/Dodatečné vybavení/Options supplémentaires/Επιπλέον επιλογές/Opzioni aggiuntive/ Opciones adicionales:

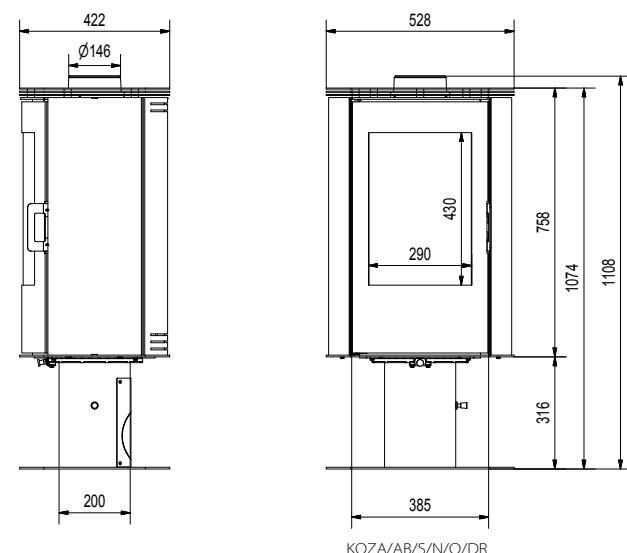

# ORBIT



<b>kW</b> 7	<b>&lt;kW&lt;</b> 5,5-9	 ~76%	 150	<b>CO</b> 0,09%
<b>PM</b> 40	 250	 99	 300x359	<b>EEI</b> 100,18

Wyposażenie/Equipment/Ausstattung/Оборудование/  
Vybavení/Equipement/Εξοπλισμός/Attrezzatura/Equipamiento:



Dodatkové opcje/Additional options/Zusätzliche Optionen/  
/Дополнительные опции/Dodatečné vybavení/Options supplémen-  
taires/Επιπλέον επιλογές/Opzioni aggiuntive/ Opciones adicionales:

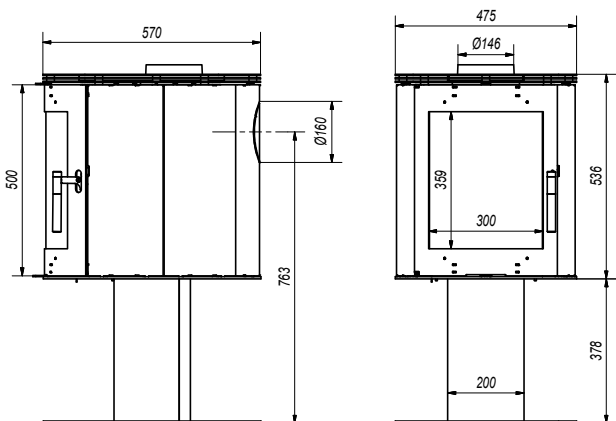

KOZA/ORBIT



KOZA AB S N

# THOR / THOR VIEW



# FALCON / FALCON VIEW



<b>kW</b> 8	<b>&lt;kW&lt;</b> 5,5-15	<b>Efficiency</b> ~83%	<b>Ø</b> 150	<b>CO</b> 0,10%
<b>PM</b> 38	<b>°C</b> 175	<b>kg</b> 160 140	<b>mm</b> 429x689	<b>EEl</b> 109,32

<b>kW</b> 10	<b>&lt;kW&lt;</b> 8-13	<b>Efficiency</b> ~82%	<b>Ø</b> 150	<b>CO</b> 0,07%
<b>PM</b> 38	<b>°C</b> 215	<b>kg</b> 132 128	<b>mm</b> 330x430	<b>EEl</b> 108

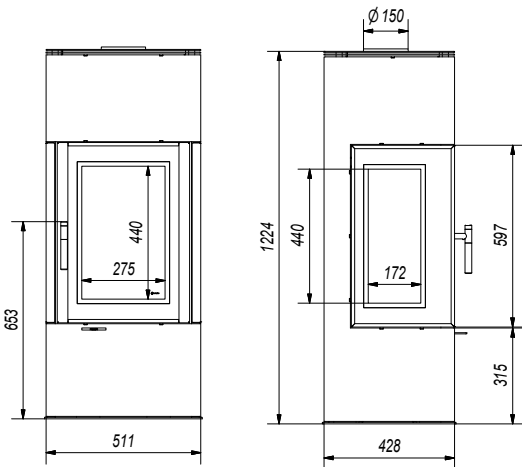

THORVIEW

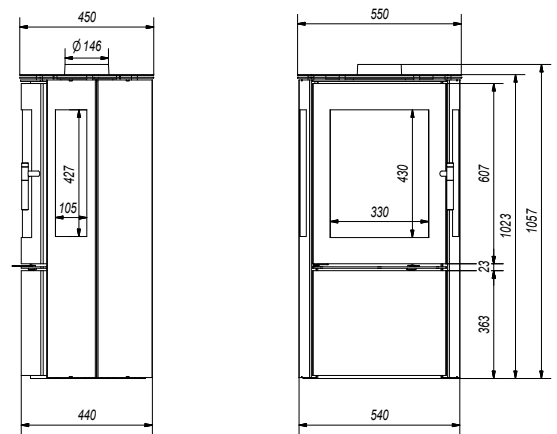

FALCONVIEW

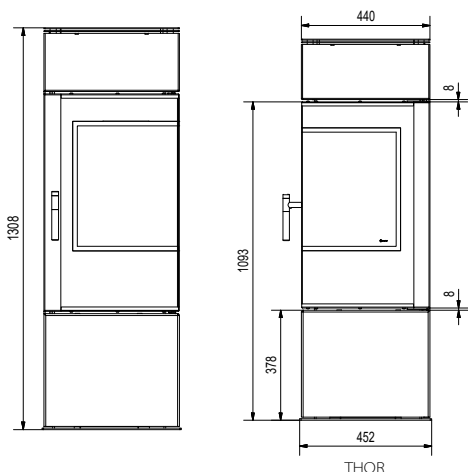

THOR

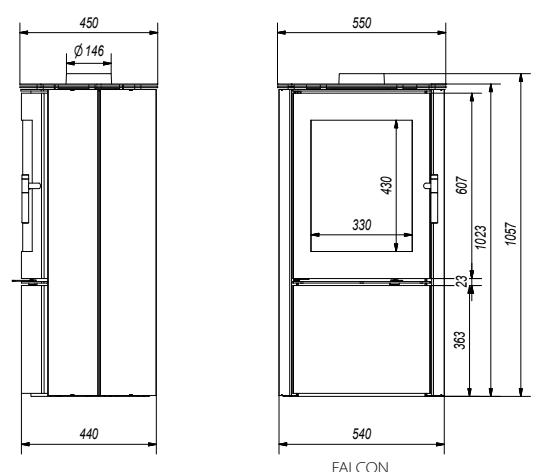

FALCON



# JUNO



<b>kW</b> 12	<b>&lt;kW&lt;</b> 6-16	 ~75%	 160	<b>CO</b> 0,10%
<b>PM</b> 34	 320	 200	 707x415	<b>EEl</b> 98,88

Wyposażenie/Equipment/Ausstattung/Оборудование/  
Vybavení/Equipement/Εξοπλισμός/Attrezzatura/Equipamiento:

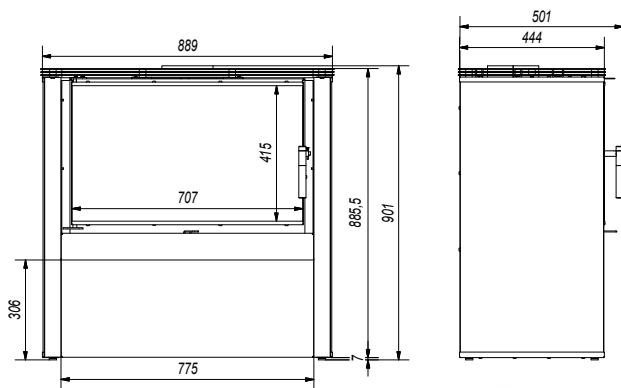

JUNO/12/C  
JUNO/12/B



# KOZA VEGA



<b>kW</b> 6	<b>&lt;kW&lt;</b> 3,5-8	 ~78%	 130 150	<b>CO</b> 0,10%
<b>PM</b> 21	 280	 90	 380x493	<b>EEl</b> 102,79

Wyposażenie/Equipment/Ausstattung/Оборудование/  
Vybavení/Equipement/Εξοπλισμός/Attrezzatura/Equipamiento:



# KOZA K5



<b>kW</b> 7	<b>&lt;kW&lt;</b> 5,5-9	 ~76%	 130 150	<b>CO</b> 0,09%
<b>PM</b> 40	 250	 118	 288x381	<b>EEl</b> 100,18

Wyposażenie/Equipment/Ausstattung/Оборудование/  
Vybavení/Equipement/Εξοπλισμός/Attrezzatura/Equipamiento:

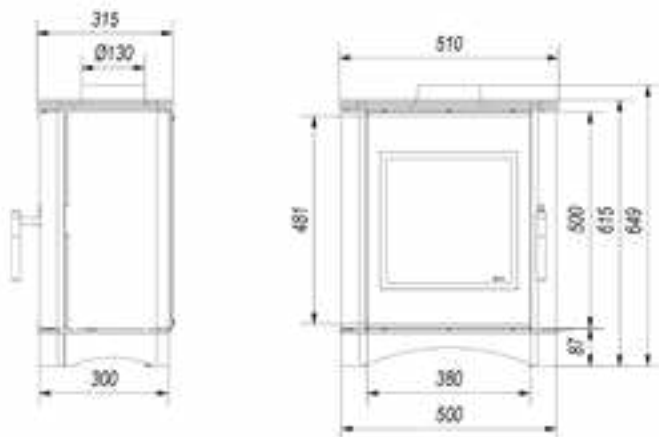

KOZA VEGA/150  
KOZA VEGA/130

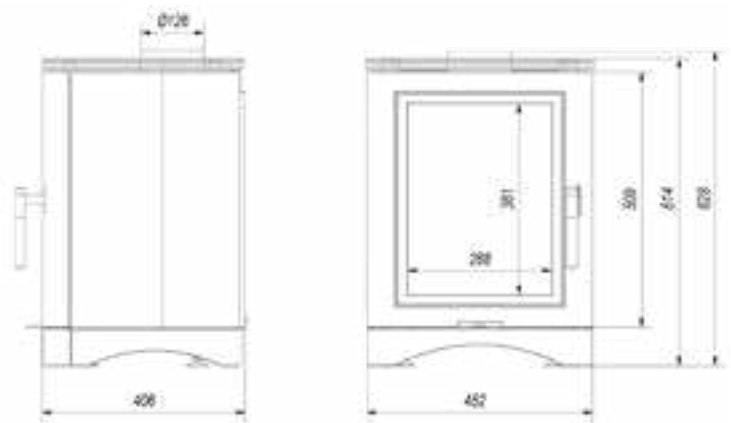

KOZA VEGA/150  
KOZA VEGA/130

# KOZA K5 S



<b>kW</b>	<b>&lt;kW&lt;</b>			<b>CO</b>
7	5,5-9	~76%	150	0,09%

<b>PM</b>				<b>EEl</b>
40	250	110	288x381	100,18

Wyposażenie/Equipment/Ausstattung/Оборудование/  
 Vybavení/Equipement/Εξοπλισμός/Attrezzatura/Equipamiento:



# KOZA K5 S W



<b>kW</b>	<b>&lt;kW&lt;</b>			<b>CO</b>
7	5,5-9	~76%	150	0,09%

<b>PM</b>				<b>EEl</b>
40	250	125	288x381	100,18

Wyposażenie/Equipment/Ausstattung/Оборудование/  
 Vybavení/Equipement/Εξοπλισμός/Attrezzatura/Equipamiento:

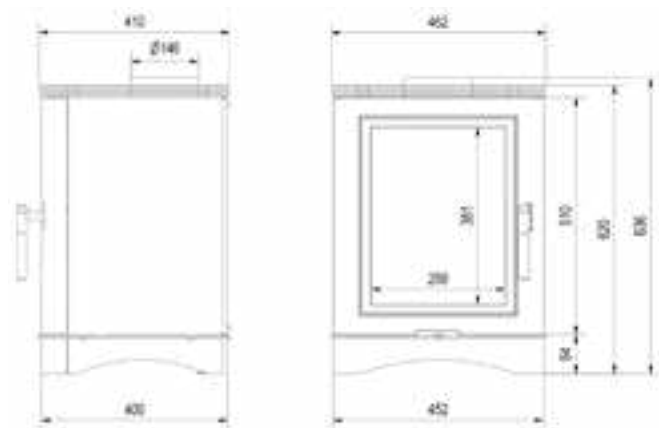

KOZA/K5/S

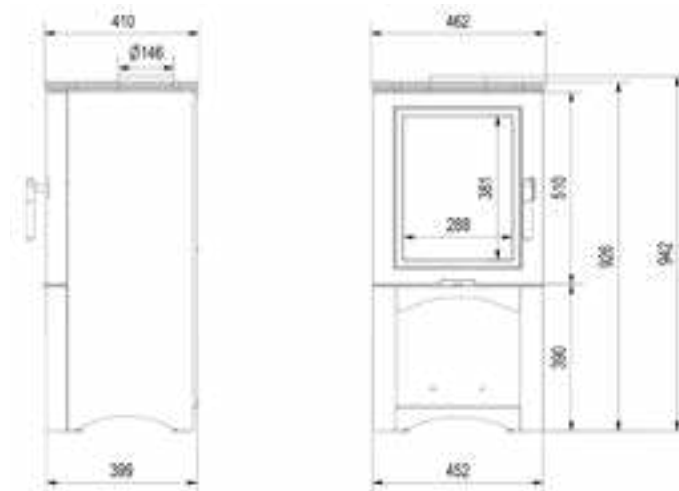

v

# KOZA K5 S W D



kW	<kW<			CO
7	5,5-9	~76%	150	0,09%

PM				EEl
40	250	132	288x381	100,18

Wyposażenie/Equipment/Ausstattung/Оборудование/  
Vybavení/Equipement/Εξοπλισμός/Attrezzatura/Equipamiento:



# KOZA K5 S N



kW	<kW<			CO
7	5,5-9	~76%	150	0,09%

PM				EEl
40	250	119	288x381	100,18

Wyposażenie/Equipment/Ausstattung/Оборудование/  
Vybavení/Equipement/Εξοπλισμός/Attrezzatura/Equipamiento:

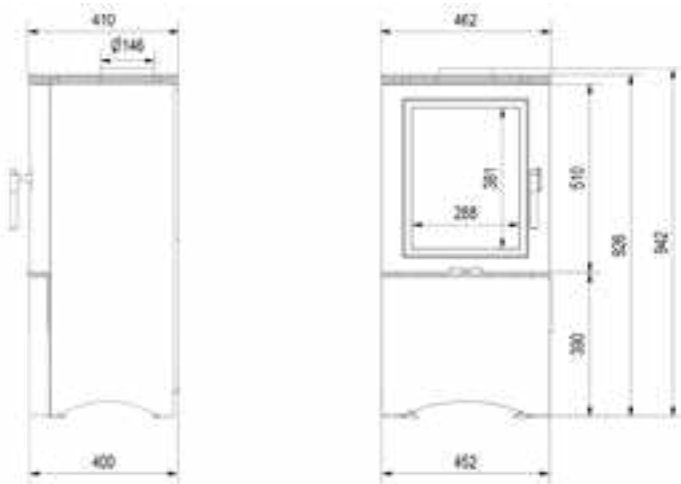

KOZA/K5/S/W/D

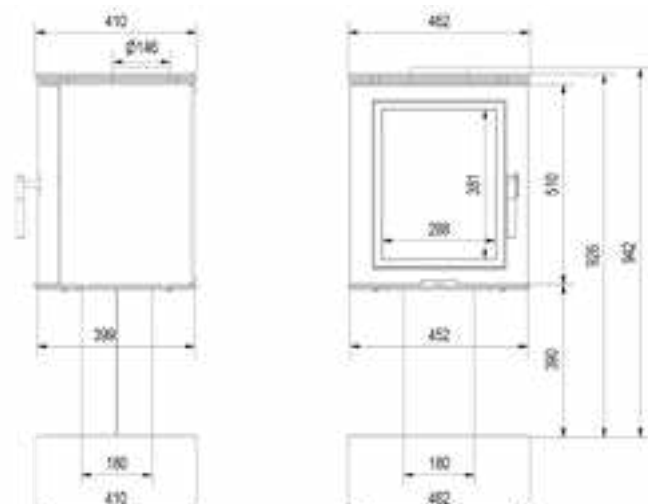

KOZA/K5/S/N

# TITAN



kW	<kW<			CO
11	8-14	~80%	150	0,10%

PM				EEl
18	270	139	326x420	15,40

Wyposażenie/Equipment/Ausstattung/Оборудование/  
 Vybavení/Equipement/Εξοπλισμός/Attrezzatura/Equipamiento:

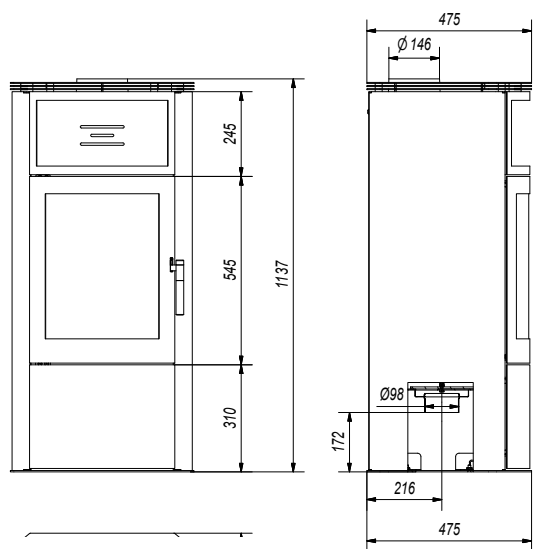

KOZA/TITAN

# TITAN G



kW	<kW<			CO
11	8-14	~80%	150	0,10%

PM				EEl
18	270	150	326x420	15,40

Wyposażenie/Equipment/Ausstattung/Оборудование/  
 Vybavení/Equipement/Εξοπλισμός/Attrezzatura/Equipamiento:

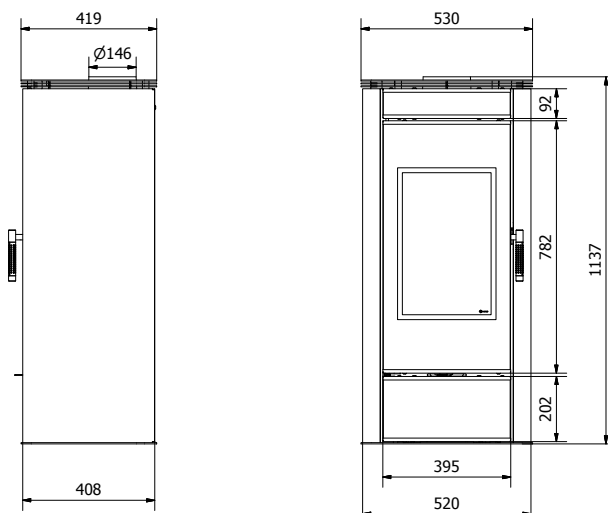

KOZA/TITAN/G

# TITAN G R



kW

11

<kW<

8-14



~80%



150

CO

0,10%

PM

18



270



148



326x420

EEI

15,40

Wyposażenie/Equipment/Ausstattung/Оборудование/  
Vybavení/Equipement/Εξοπλισμός/Attrezzatura/Equipamiento:

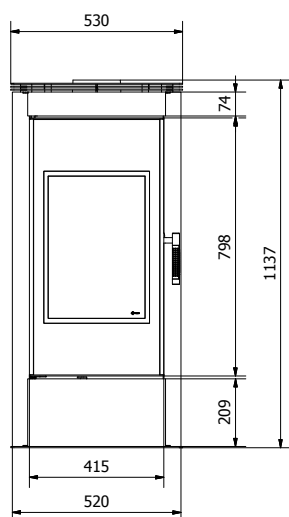
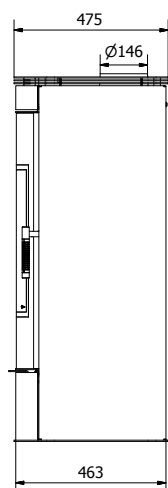

KOZA/TITAN/G/R



# PROTON



kW	<kW<			CO
8	6-9	~82%	150	0,08%

PM				EEl
16	255	143	307x390	108

Wyposażenie/Equipment/Ausstattung/Оборудование/  
 Vybavení/Equipement/Εξοπλισμός/Attrezzatura/Equipamiento:

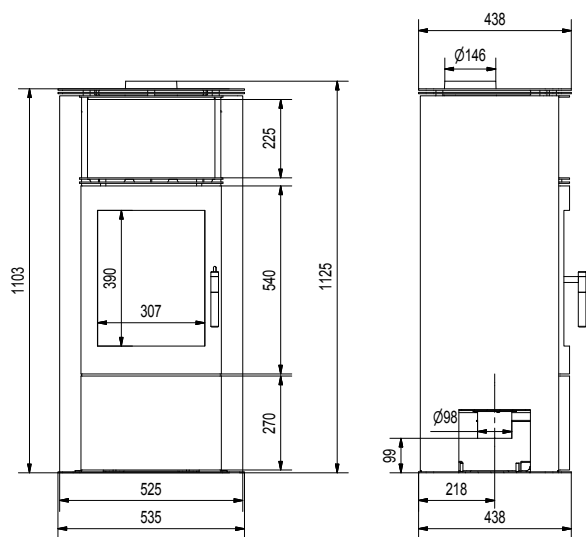

PROTON

# EPSILON



kW	<kW<			CO
8	6-9	~82%	150	0,08%

PM				EEl
16	255	143	307x390	108

Wyposażenie/Equipment/Ausstattung/Оборудование/  
 Vybavení/Equipement/Εξοπλισμός/Attrezzatura/Equipamiento:

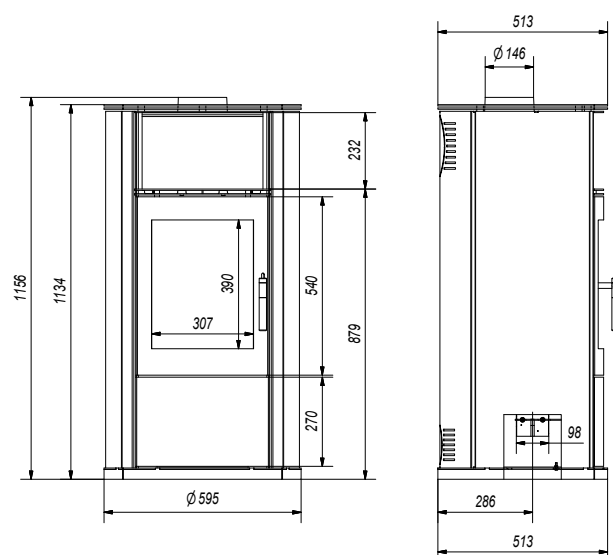

EPSILON



# PICARD



<b>kW</b> 9	<b>&lt;kW&lt;</b> 8-12	 ~80%	 150	<b>CO</b> 0,10%
<b>PM</b> 37	 231	 137	 341x430	<b>EEl</b> 107

Wyposażenie/Equipment/Ausstattung/Оборудование/  
Vybavení/Equipement/Εξοπλισμός/Attrezzatura/Equipamiento:



PICARD





# KOZA ENYO



kW	<kW<	~80%	180	CO
6	4-8			0,10%

PM	°C	kg		EEI
30	239	146	259x406	107

Wyposażenie/Equipment/Ausstattung/Оборудование/  
 Vybavení/Equipement/Εξοπλισμός/Attrezzatura/Equipamiento:

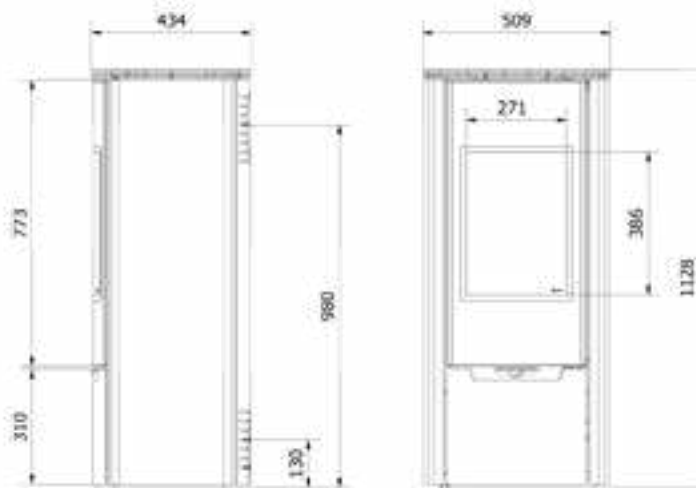

KOZA/ENYO

# KOZA ENYO panoramiczny



kW	<kW<	~80%	180	CO
6	4-8			0,10%

PM	°C	kg		EEI
30	239	144	271x386	107

Wyposażenie/Equipment/Ausstattung/Оборудование/  
 Vybavení/Equipement/Εξοπλισμός/Attrezzatura/Equipamiento:



KOZA/ENYO



## KOZA K6



kW	<kW<	kW <sub>0</sub>	
8 8	7-11 5,4-10,5	- 2	~76% ~76%
PM			
88,9 -	360 290	118 120	130/150 130/150
CO	bar	EEl	
0,30% 0,30%	- 2	100,18 100,18	- 5





KOZA K6

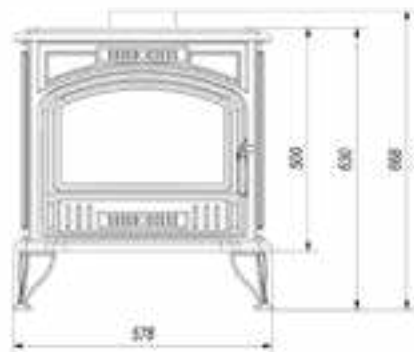
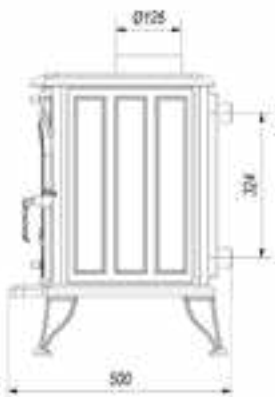

KOZA/K6

Wyposażenie/Equipment:/Ausstattung:/Оборудование/  
 Vybavení/Equipment/Εξοπλισμός/Attrezzatura/  
 Equipamiento:

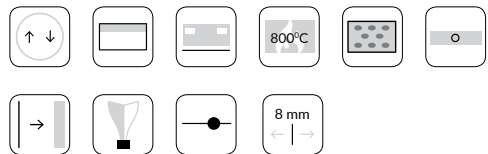

Dodatkové opcje/Additional options/Zusätzliche Optionen/  
 Дополнительные опции/Dodatečné vybavení/  
 Options supplémentaires/Επιπλέον επιλογές/Opzioni  
 aggiuntive/ Opciones adicionales:





KOZA K7



KOZA/K7/ASDP



KOZA/K7/TF

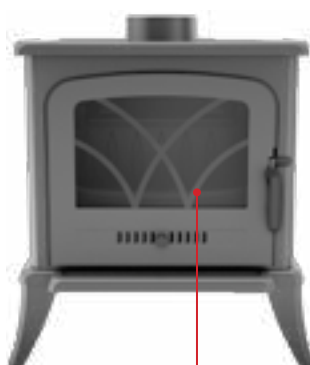

SZPROS/W/K7



SZPROS/M/K7



## KOZA K7



kW 5	<kW< 3-8	~71%	130	CO 0,30%
PM 187	°C 340	kg 75	289x189	EEI 93,66

Wyposażenie/Equipment/Ausstattung/Оборудование/  
Vybavení/Equipement/Εξοπλισμός/Attrezzatura/Equipamiento:

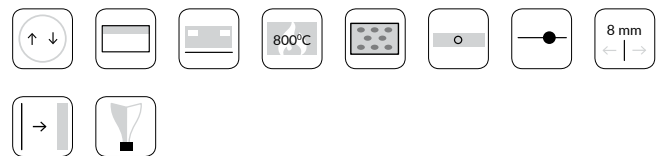

Dodatkové opcje/Additional options/Zusätzliche Optionen/  
/Дополнительные опции;/Dodatečné vybavení;/Options supplémentaires;/Επιπλέον επιλογές;/Opzioni aggiuntive;/ Opciones adicionales:

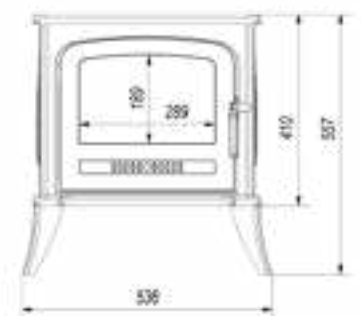
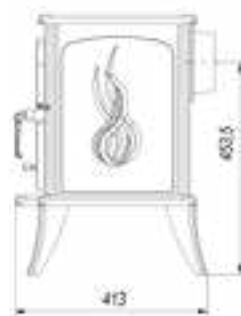
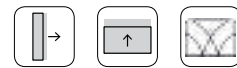

KOZA/K7

# KOZA K8



kW	<kW<	~75%	130	CO
9	5-11			0,19%
PM	°C	kg	341x269	EEI
23	385	126		100,18

Wyposażenie/Equipment/Ausstattung/Оборудование/  
 Vybavení/Equipement/Εξοπλισμός/Attrezzatura/Equipamiento:

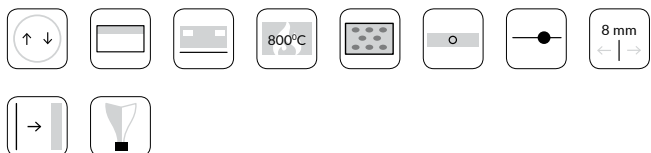

Dodatkové opcje/Additional options/Zusätzliche Optionen:  
 /Дополнительные опции/Dodatečné vybavení/Options supplémentaires/Επιπλέον επιλογές/Opzioni aggiuntive/ Opciones adicionales:

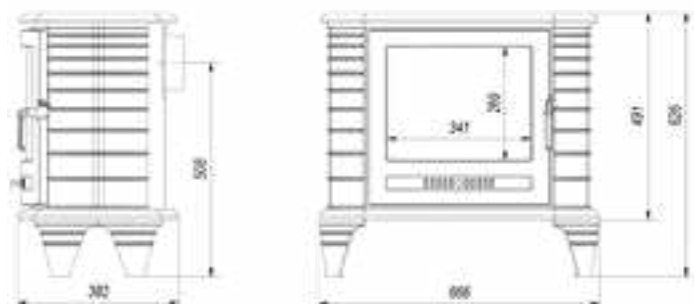

KOZA/K8



KOZA/K8/T





KOZA K8 T



KOZA/K8/ASDP



KOZA/K8/TF



## KOZA K9



kW

10

<kW<

5,5-13,5



~75%



130

CO

0,15%

PM

14



290



165



341x269

EEL

98,90





KOZA K9

## KOZA K9 PW



A

kW	<kW<	kW0		CO	
9	5,3-12,7	2,5	~76%	0,30%	
PM				EEl	
56	330	160	150	98,88	7

Wyposażenie/Equipment/Ausstattung/Оборудование/  
Vybavení/Equipement/Εξοπλισμός/Attrezzatura/  
Equipamiento:

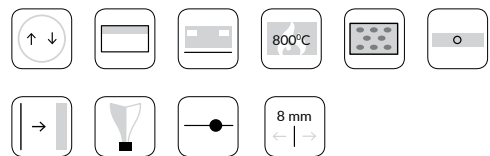

Dodatkové opcje/Additional options/Zusätzliche Optionen/  
Дополнительные опции/Dodatečné vybavení/  
Options supplémentaires/Επιπλέον επιλογές/Opzioni  
aggiuntive/Opciones adicionales:

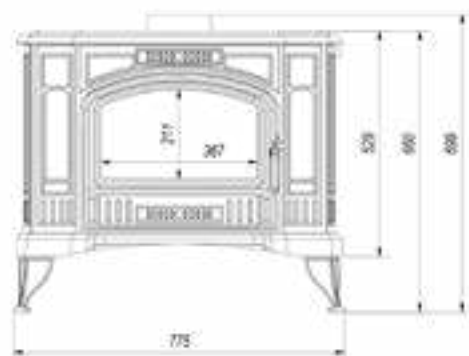
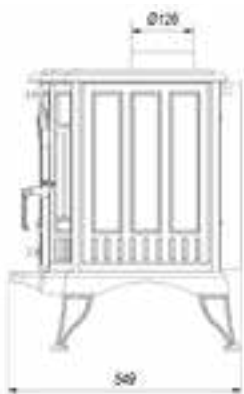

KOZAK9

# KOZA K10



<b>kW</b> 10	<b>&lt;kW&lt;</b> 6-13	 ~75%	 130/150	<b>CO</b> 0,19%
<b>PM</b> -	 334	 109	 168x224	<b>EEl</b> 98,88

Wyposażenie/Equipment/Ausstattung/Оборудование/  
 Vybavení/Equipement/Εξοπλισμός/Attrezzatura/Equipamiento:

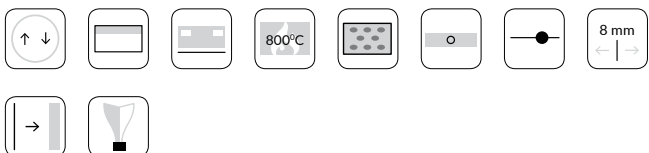

Dodatkové opcje/Additional options/Zusätzliche Optionen:  
 /Дополнительные опции/Dodatečné vybavení/Options supplémentaires/  
 Επιπλέον επιλογές/Opzioni aggiuntive/ Opciones adicionales:

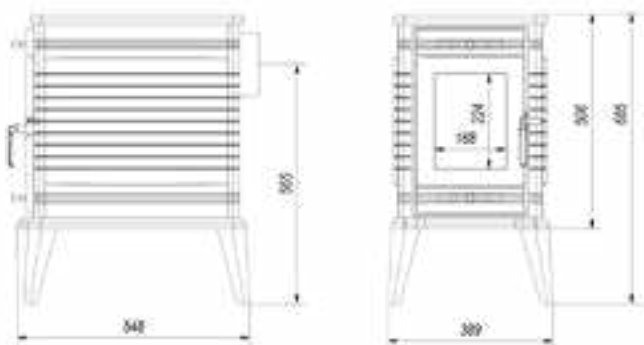

KOZA/K10



KOZA K10



FAJERKI



KOZA/K10/130/ASDP  
KOZA/K10/150/ASDP



KOZA/K10/130/TF  
KOZA/K10/150/TF







ANTARES

# ANTARES



kW

10

<kW<

6-12



~81%



150

CO

0,10%

PM

35



215 °C



186 kg



351x638







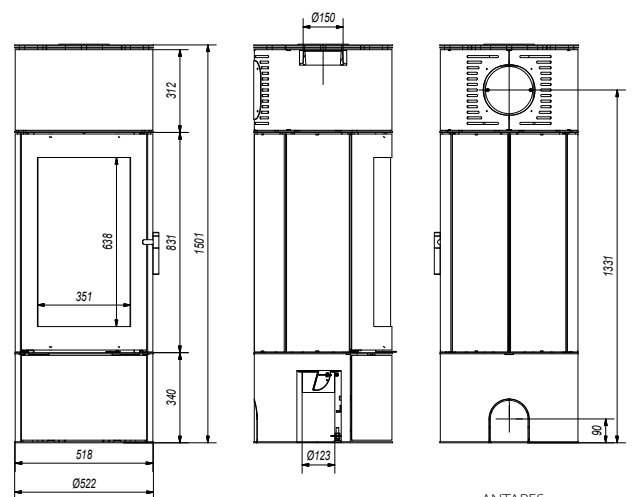





EEI

108,50

Wyposażenie/Equipment/Ausstattung/Оборудование/  
 Vybavení/Equipment/Εξοπλισμός/Attrezzatura/Equipamiento:



ANTARES

	 kW	 <kW<		 CO	 PM	 EEI	 °C		 A++	 BlmSchV 2		 Eco design	kg
WK 440	6,5	3.0 - 9.3	80	0,2	53	105,4	327	130	A			✓	130
BLANKA KAFEL	8	7.5 - 11.0	78	0,1	36	102,79	285	160	A	✓		✓	247
NADIA 8	7	3.0 - 9.0	80	0,1	38	105,4	245	200	A	✓	✓	✓	274
AB	8	5.5 - 10.5	78	0,08	39	102,79	265	150	A	✓		✓	126
AB2	10	4-12	80	0,09	15	105,4	280	150	A	✓	✓	✓	150
THOR / THOR VIEW	8	5.5 - 10.0	83	0,1	38	109,32	175	150	A+	✓	✓	✓	160 147
FALCON / FALCON VIEW	10	8.0-13.0	82	0,07	38	108	215	150	A+	✓	✓	✓	132 128
ORBIT	7	5.5 - 9.0	76	0,09	40	100,18	250	150	A	✓		✓	99
JUNO	12	6.0 - 16.0	75	0,1	34	98,88	320	150	A	✓		✓	200
VEGA	6	3.5 - 8.0	78	0,1	21	102,79	280	130	A	✓		✓	90
K5	7	5.5 - 9.0	76	0,09	40	100,18	250	130	A	✓		✓	118
K5 S	7	5.5 - 9.0	76	0,09	40	100,18	250	150	A	✓		✓	110
K6	8	7.0 - 11.0	76	0,3	88,9	100,18	360	130	A			✓	119
K7	5	3.0 - 8.0	71	0,3	187	93,66	340	130	A			✓	75
K8	9	5.0 - 11.0	75	0,19	23	100,18	385	130	A			✓	126
K9	10	5.5 - 13.5	75	0,15	14	98,90	290	130	A			✓	165
K10	10	6.0 - 13.0	75	0,19	19	98,88	334	130	A	✓		✓	109
ANTARES	10	6.0 - 12.0	81	0,10	35	108,50	215	150	A+	✓	✓	✓	186
TITAN / TITAN G / TITAN G R	11	8 - 14	80	0,10	18	105,40	270	150	A	✓	✓	✓	139 150 148
PROTON	8	6-9	82	0,08	16	108	255	150	A+	✓	✓	✓	143
EPSILON	8	6-9	82	0,08	16	108	255	150	A+	✓	✓	✓	143
PICARD	9	8-12	80	0,10	37	107	231	150	A+	✓	✓	✓	137
ENYO / ENYO R	6	4-8	80	0,10	30	107	239	180	A+	✓	✓	✓	144 / 146



35	316x285	✓			✓		✓		✓	✓		✓			
30	384x406	✓			✓		✓		✓	✓	✓	✓			
30	452x512	✓			✓	✓	✓		✓	✓	✓				✓
25	290x427	✓			✓		✓		✓	✓	✓	✓			
50	540x430	✓			✓		✓		✓	✓	✓	✓			
30	429x689	✓	✓		✓		✓		✓		✓	✓			✓
30	330x430	✓			✓		✓		✓		✓	✓			
25	300x359	✓			✓		✓		✓			✓			
35	707x415	✓			✓		✓		✓		✓	✓			✓
25	380x493	✓			✓		✓		✓			✓			✓
25	288x381	✓			✓			✓				✓			
25	288x381	✓			✓		✓		✓			✓			
35	367x211	✓			✓			✓				✓			
30	289x189	✓			✓			✓				✓			
35	341x269	✓		✓	✓			✓				✓			
35	367x211	✓			✓			✓				✓			
35	168x224	✓			✓			✓				✓			
30	351x638	✓					✓		✓		✓				
30	326x420	✓					✓		✓			✓			
30	307x390	✓					✓		✓						
30	307x390	✓					✓		✓						
25	341x430	✓					✓		✓						
30	259x406 271x386	✓					✓		✓			✓			✓

# Piec na pellet VIKING



8	2,5-8	~86,5%	80	205	150	168x224	120,60

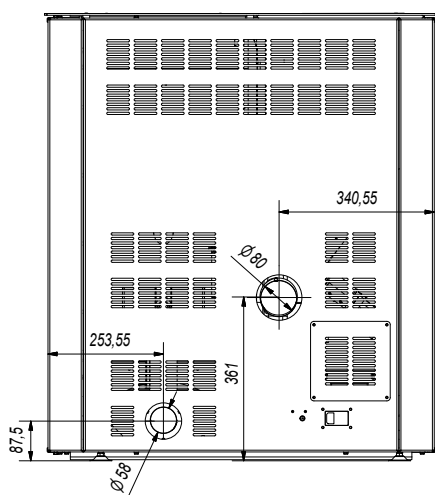

VIKING/B

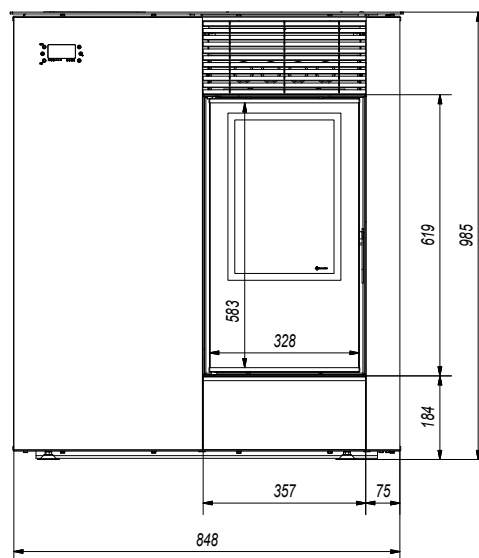

VIKING/B

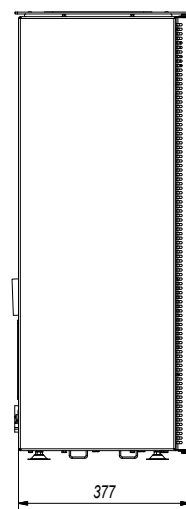





# Tworzymy atmosferę, cieplą atmosferę...

„We create a special warm, welcoming atmosphere...”

„Wir schaffen Atmosphäre, warme Atmosphäre...”

„Мы создаём атмосферу, атмосферу тепла...”

„Tvoříme atmosféru, teplou atmosféru...”

„Nous créons une atmosphère, un accueil chaleureux...”

„Έχουμε δημιουργήσει μια ατμόσφαιρα, μια ζεστή ατμόσφαιρα...”

„Creiamo un'atmosfera, un'atmosfera calda...”

„Creamos un ambiente, un ambiente cálido...”

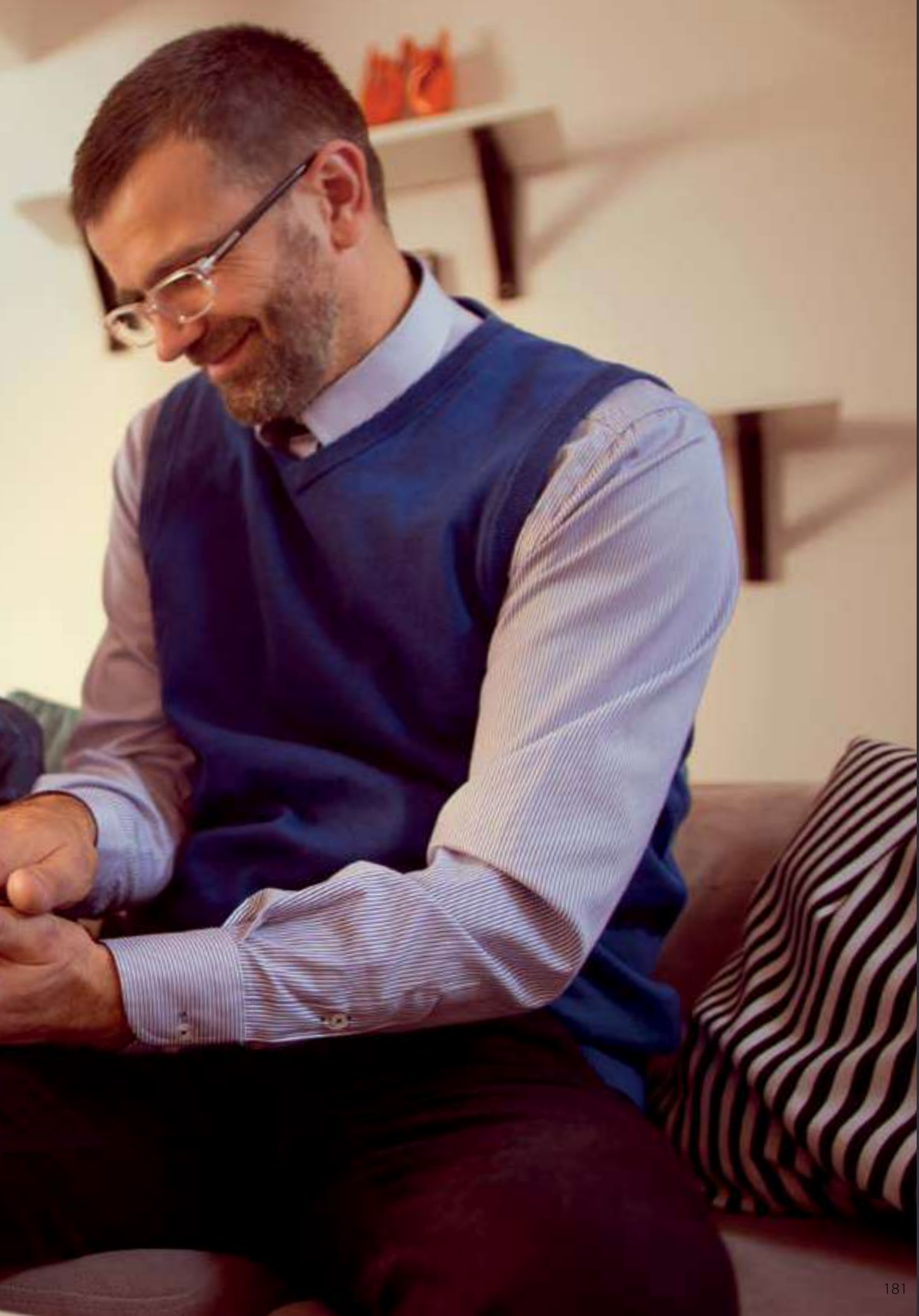

## ZALETY KRATEK KOMINKOWYCH

ADVANTAGES OF FIREPLACE GRIDS/VORTEILE DER LÜFTUNGSGITTER/ПРЕИМУЩЕСТВА КАМИННЫХ РЕШЕТОК/ VENTAJAS DE LOS DIFUSORES PARA CHIMENEAS

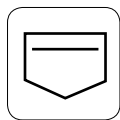

kieszień pozwalająca zamontować kratkę w ścianie  
pocket which gives possibility to mount grid into the wall  
Lüftungsgittertasche hilft bei der Montage der Lüftungsgitter  
зогнутый захват, который закрепляет решетку в кармане  
instalační rámeček umožňuje montáž na otvor ve zdi  
cadre à encastrer permet de fixer la grille d'aération dans le mur  
πλαίσιο, το οποίο διευκολύνει την τοποθέτηση περισίδας στον τοίχο  
tasca permette mettere griglie in parete  
el marco de montaje facilita la instalación de la rejilla



ramka kratki wykonana z blachy, powlekana galwanicznie  
grid's frame is made of sheet metal and then plated  
Lüftungsgitterrahmen gefertigt aus Blech, dann galvanisch beschichtet  
рамка изготовлена из черной листовой стали с гальваническим покрытием  
rámeček vyrobený z ocelového plechu, následně galvanicky povlakovaný  
cadre de grilles galvanisées et revêtues sont fabriquées de l'acier avec le revêtement électrolytique  
μεταλλική κορνίζα περισίδας, με επικάλυψη γαλβανιζέ  
La cornice è costituito da griglie di metallo e poi galvanizzare, questo fornisce la durezza e resistenza termico aggiunta protegge contro i danni meccanici  
marco de la rejilla de chapa y galvanizado



ramka kratki wykonana z wysokiej jakości stali nierdzewnej o fakturze szlifowanej  
the frame of the ventilation grid made of a high quality stainless steel of grinded texture  
Rahmen der Lüftungsgitter aus nichtrostender Stahl, geschliffen  
рамка изготовлена из нержавеющей стали высокого качества и отшлифована  
rám mřížky vyroben z vysoce kvalitní nerezové oceli s broušeným povrchem  
cadre de grilles polis sont fabriquées en acier inoxydable de haute qualité avec une texture polie  
κορνίζα περισίδας από σίδηρο υψηλής ποιότητας  
la cornice è costituito da griglie di alta qualità acciaio Inox  
marco de rejilla de material no oxidable

gięty uchwyt mocujący kratkę w kieszeni  
bent bracket to fit grid in a pocket  
gebogener Griff hilft bei der Montage Lüftungsgitter in einer Lüftungsgittertasche  
изогнутый захват которой монтирует решетку в кармане  
ohýbaný držák upevňující mřížku v kapse  
anses pliées permettent d'encaster la grille d'aération dans le cadre  
ελαστικά στηρίγματα, τα οποία στερεώνουν την περισίδα μέσα στο πλαίσιο  
piegati maniglia montaggio della griglia in tasca  
mando de la rejilla muy discreto

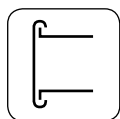
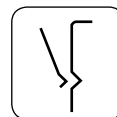

nowoczesny kształt i specjalna budowa kratki  
modern shape  
modernes Design und spezielle Konstruktion der Lüftungsgitter  
временный дизайн

moderní design K dispozici v barvách: bílá, krémová, grafit, černá a nerez  
design moderne et construction spéciale  
μοντέρνο σχέδιο και ειδική κατασκευή περισίδας  
design moderno e una costruzione speciale griglia  
diseño moderno y construcción especial de la rejilla



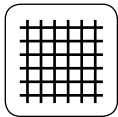

siatka ze stali nierdzewnej wysokiej jakości, o regularnym układzie dziurek  
 stainless steel mesh with high quality, with a regular pattern of holes  
 Netz der Lüftungsgitter ist aus rostfreiem Stahl gefertigt, mit regulären Löchern  
 сетка из нержавеющей стали высокого качества имеющая геометрически правильную систему отверстий  
 sítka z nerezí s pravidelným rozstupem otvorů  
 filet en acier inoxydable de haute qualité, à mailles régulières  
 σήτα από ανοξείδωτο σίδηρο υψηλής ποιότητας  
 hohe Qualität nichtrostständer Streckstahl  
 emparrillado de la rejilla de material inoxidable

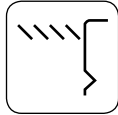

dolna ramka, do której przymocowane są od wewnętrznej strony żaluzje, a od zewnętrznej uchwyty mocujące  
 lower frame, to which are mounted on inside blinds, and the outer fixing brackets  
 unterer Rahmen zu dem von der Innenseite die Jalousien befestigt sind und von Außenseite die Befestigungsgriffe  
 Внутренняя рамка, к которой крепятся жалюзи с внутренней стороны, а с внешней стороны изогнутый захват  
 spodní rám, ke kterému je instalována z vnitřní strany žaluzie a z vnější strany ovládací knoflík  
 encadrement intérieur avec une persienne fixée d'un coté et les anses de l'autre  
 πλαίσιο, το οποίο στερεώνει εσωτερικά τα γρίλια και εξωτερικά στηρίγματα για τον τοίχο  
 bassa cornice per cui allegato sono dal lato interno taparella e le staffe di montaggio esterno  
 pre-marco de instalación

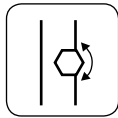

wygodna gałka regulacyjna  
 comfortable adjustment knob  
 komfortabler Handgriff  
 удобные ручки для регулирования

snadné nastavení regulace  
 bouton maniable pour le réglage  
 βολικό πόμολο για τα γρίλια  
 comodo manopola per la regolazione  
 cómodo botón de regulación

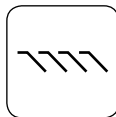

specjalnie wyprofilowane nieruchome pióra/kierownice  
 specially profiled fixed feathers/wheels  
 Unbewegte Lamellen aus Stahl schützt Innesicht der Gitter  
 неподвижные перья специальной формы  
 speciálně tvarované stacionární žaluzie  
 spécialement en forme fixe du plume  
 ειδικά ρυθμιζόμενα σταθερά γρίλια  
 forma speciale stazionario e direzionabile  
 posición de mantenimiento, laminillas para evitar la visión del interior

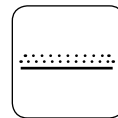
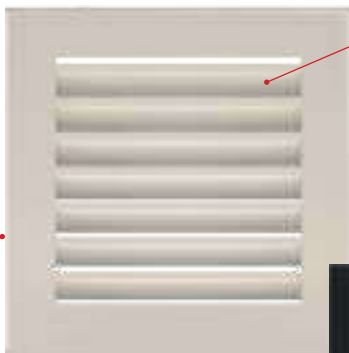

powierzchnia kratki pokryta jest farbą proszkową  
 grids surface is covered with powder paint  
 Die Lüftungsgitter sind pulverbeschichtet  
 поверхность решеток покрыта порошковой краской  
 povrch mřížky je potažen práškovou barvou  
 grilles d'aération peintes  
 η επιφάνεια περιόδας είναι καλυμμένη με ειδικό χρώμα  
 superficie griglie verniciato sono coperti vernice polvere  
 rejillas pintadas al polvo

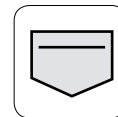

panel górny wykonany ze stali nierdzewnej  
 the upper panel of the floor grid made of stainless steel  
 Abdeckung aus nichtrostender Stahl  
 внешняя панель изготовлена из нержавеющей стали  
 horní panel z nerezové oceli  
 un panneau supérieur est fabriqué en acier inoxydable poli  
 το πάνω της περιόδας διατέδου από ανοξείδωτο σίδηρο  
 pannello superiore in acciaio inox  
 tapa de material inoxidable

kieszzeń kratki wykonana z blachy czarnej  
 the pocket of the grid made of steel  
 Gittertasche aus schwarzes Blech  
 карман решётки изготовлен из черной стали  
 rámeček mřížky vyroben z černého plechu  
 poche de grille fabriquée en acier noire  
 prelaquée en poudre  
 το πλαίσιο στερέωσης περιόδας από μαύρο χάλυβα  
 griglia Vano in lamiera nero  
 marco de chapa negro

profilowane kanały w kieszeniach, kształt wgłębień dopasowany do uchwytów co gwarantuje właściwe mocowanie kratki  
 profiled channels in the pocket, matched to the shape of the handle recesses which guarantee the proper grids mounting  
 profilierte Kanäle In der Lüftungsgittertasche, Vertiefungen passend zum Lüftungsgittergriff, was richtige Befestigung der Lüftungsgitter sichert  
 Профилированные каналы в карманах, форма углубления соответствует форме захвата. Это обеспечивает удобный и надежный монтаж решетки  
 profilované kanály v rámečcích, tvar který slouží pro manipulaci, a který zajišťuje správné montážní usazení  
 profilés de montage et anses ajustées assurent le montage correct  
 το πλαίσιο στερέωσης περιόδας διαθέτει ειδικά κανάλια για το προφίλ των στηριγμάτων περιόδας  
 canali a forma di in tasca forma delle cavità adatto a gestire che assicura fissaggio corretto griglia  
 canales perfilados para asegurar la perfecta posición de la rejilla

## KRATKI KOMINKOWE

FIREPLACE GRIDS/LÜFTUNGSGITTER/КАМИННЫХ РЕШЕТОК/ DIFUSORES PARA CHIMENEAS



Kratka Fresh / Fresh grid / Lüftungsgitter Fresh / Решетка Fresh / Mřížka Fresh / Grille d'aération Fresh / Περίοδα Fresh / Griglia Fresh / Rejilla Fresh



Tunel / Tunnel / Tunnel / Туннель / Tunnel / Grilles d'aération tunel / Τούνελ / Tunnel / Túnel



Kratka Luft / Luft grid / Lüftungsgitter Luft / Решетка Luft / Mřížka Luft / Grille d'aération Luft / Περίοδα Luft / Griglia Luftr / Rejilla Luft / Mriežka Luft



Luft narožna / Corner grids / Lüftungsgitter Eckig / Решетка Угловая / Rohová mřížka luft / Grille d'aération blanche angulaire luft / Περίοδα luft γωνιακή / Griglia bianco angolare / Rinconera



Ozdobne / Decorative / Verziert / Декоративные / Mřížky dekorativní / Grilles d'aération décoratives / Διακοσμητικά / decorativo/Decorativos / Ornamental



Kratka podłogowa / Floor grids / Fußbodengitter / Напольная решетка / Podlahová mřížka / Grille de plancher / Επιδαπέδια σχάρα / Griglia per pavimento / Rejilla de suelo



Wymiar kieszeni (mm) / Pocket dimensions (mm) / Maße der einfachen Lüftungsgitter (mm) / Размер решеток (мм) / Montážní rozměr (mm) / Dimensions du cadre à encastrer (mm) / Διαστάσεις Τοποθέτησης / Dimensioni tasca (interno) / Dimensión premarco (mm)



Wymiar kratki prostych (mm) / Dimensions of simple grids (mm) / Maße der einfachen Lüftungsgitter (mm) / Размер решеток с жалюзи (мм) / Vnější rozměr mřížek (mm) / Dimensions des grilles d'aération simples (mm) / Διαστάσεις περίοδας ίσας σε χιλιοστά / Dimensioni griglie semplice / Dimensión rejilla sencilla (mm)



Wymiar kratki prostych z żaluzją (mm) / Dimensions of simple grids with blinds (mm) / Maße der einfachen Lüftungsgitter mit Jalousien (mm) / Размер решеток с жалюзи (мм) / Rozměry jednoduchých mřížek se žaluziemi (mm) / Dimensions des grilles d'aération à volets mobiles (mm) / Διαστάσεις περίοδας ίσας με γρίλλια σε χιλιοστά / Dimensioni griglie semplice con tapparella / Dimensión rejilla regulable (mm)



Pole czynne kratki (cm²) / Air flow in (cm²) / Luftdurchsatz (cm²) / Площадь потока воздуха (cm²) / Plocha průchodu vzduchu (cm²) / Surface de passage (d'une grille d'aération) / Επιφάνεια λειτουργίας περίοδας (cm²) / Settore griglia attivo (cm²) / Paso de aire (cm²)







Kratka z žaluzją / Grille with blinds / Gitter mit Jalousien / Решетка с жалюзи / Mřížka s žaluziemi / Grille avec des stores / Γρίλια με περσίδες / Griglia con tende / Rejilla con malla



Kratka prosta / Straight grid / Gerades Lüftungsgitter / Прямая сетка / Mřížka rovný / Grille d'aération tout droit / Περίδα Οσκαρ / Griglia Prosta / Rejilla simple



Kratka Oskar / Oskar grid / Lüftungsgitter Oskar / Решетка Oskar / Mřížka Oskar / Grille d'aération Oskar / Περίδα Οσκαρ / Griglia Oskar / Rejilla Oskar



Kratka Oskar z žaluzją / Oskar grid with blind / Lüftungsgitter Oskar mit Jalousie / Решетка Oskar с жалюзи / Mřížka Oskar se žaluzií / Grille d'aération Oskar à volets mobiles / Περίδα Οσκαρ με γρίλλια / Griglia Oskar con tapparella / Rejilla Oskar regulable



Kratka ABC/ ABC grid / Lüftungsgitter ABC/ Решетка ABC/ Mřížka ABC/ Grille d'aération ABC/ Περίδα Οσκαρ / Griglia ABC/ Rejilla ABC



Kratka Rustykalna / Rustical grid / Lüftungsgitter rustikal / Решетка рустик / Mřížka Rustikální / Grille d'aération Rustique / Περίδα Ρουστικ / Griglia Rustico/ Rejilla rústica / Mriežka Rustikálna



Kratka Rustyk z žaluzją / Rustical grid with blind / Lüftungsgitter rustikal mit Jalousie / Решетка рустик с жалюзи / Mřížka Rustikální se žaluzií / Grille d'aération Rustique à volets mobiles / Περίδα Ρουστικ με γρίλλια / Griglia Rustico con tapparella / Rejilla rústica regulable



Kratka Venus/ Venusgrid / Lüftungsgitter Venus/ Решетка Venus/ Mřížka Venus/ Grille d'aération Venus/ Περίδα Οσκαρ / Griglia Venus/ Rejilla Venus



Kratka Venus z kryształami Swarovski / Venus grid with crystals Swarovski / Lüftungsgitter Venus mit Swarovski Kristallen / Решетка Venus с кристаллами Swarovski / Mřížka Venus s krystaly Swarovski / Grille d'aération Venus avec des cristaux Swarovski / Περίδα Venus με κρύσταλλα Swarovski / Venus con cristalli Swarovski / Rejilla Venus con cristales de Swarovski



Okrągła FI / Round FI / Rund FI / Круглая FI / Ronde FI / Kulatá FI / Στρογγυλή FI / Arrotondare FI / Circular FI



Kratka Wind/ Windgrid / Lüftungsgitter Wind/ Решетка Wind/ Mřížka Wind/ Grille d'aération Wind/ Περίδα Οσκαρ / Griglia Wind/ Rejilla Wind/ Mriežka Wind



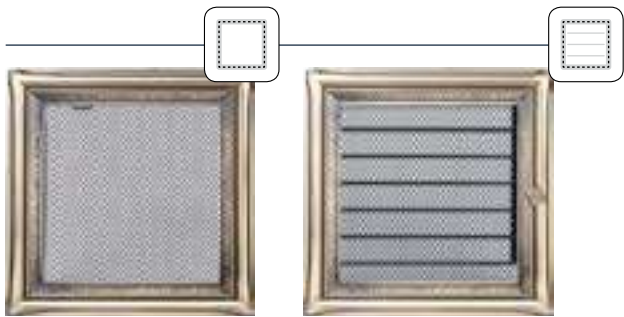

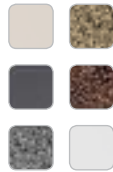

10; 12,5; 15 cm/cm

60, 70, 80 cm<sup>2</sup>/cm<sup>2</sup>



17x17, 17x30, 17x37, 17x49, 17x70 cm/cm

103, 215, 275, 369, 558 cm<sup>2</sup>/cm<sup>2</sup>



17x17, 17x30, 17x37, 17x49 cm/cm  
22x22, 22x30, 22x37, 22x45 cm/cm

72,9; 144,3; 180,3; 236,5 cm<sup>2</sup>/cm<sup>2</sup>  
126,5; 184,6; 239,2; 301,8 cm<sup>2</sup>/cm<sup>2</sup>



6x20, 6x40, 6x60, 6x80, 6x100 cm/cm

51, 111, 171, 231, 291 cm<sup>2</sup>/cm<sup>2</sup>

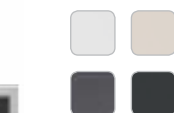

6x20, 6x40, 6x60, 6x80, 6x100, 9x20, 9x40, 9x60, 9x80,  
9x100 cm/cm

51, 111, 171, 231, 291, 102, 222, 342, 462, 582 cm<sup>2</sup>/cm<sup>2</sup>



56x56x9, 76,6x54,7x9, 54,7x76,6x9, 60x40x9, 40x60x9 cm/cm  
56x56x6, 76,6x54,7x6, 54,7x76,6x6, 60x40x6, 40x60x6 cm/cm

484, 600, 600, 412, 412 cm<sup>2</sup>/cm<sup>2</sup>  
260, 318, 318, 206, 206 cm<sup>2</sup>/cm<sup>2</sup>



164x94, 162x162, 212x102, 414x104, 613x103 mm/mm

40, 60, 45, 100, 185 cm<sup>2</sup>/cm<sup>2</sup>

	✓	✓	✓		✓	✓	✓	✓	✓		✓	✓	✓		
	✓	✓	✓		✓	✓	✓	✓	✓		✓	✓	✓		
	✓	✓	✓		✓	✓	✓	✓	✓		✓	✓	✓		
	✓	✓	✓		✓	✓	✓	✓	✓		✓	✓	✓		
	✓			✓	✓				✓						
											✓				
											✓				
	✓	✓	✓							✓					
	✓				✓										
	✓	✓	✓		✓	✓	✓	✓							
	✓	✓	✓		✓	✓	✓	✓	✓						
	✓	✓	✓		✓				✓						
	✓	✓	✓		✓				✓						
	✓	✓			✓				✓						
														✓	✓
									✓						

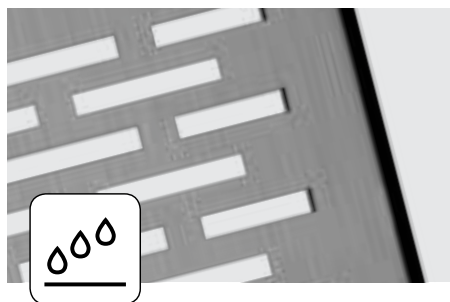

11x11	86x86	106x106	-	116x116	-	116x116	-	36
11x17	86x152	106x170	-	116x175	-	116x175	-	75
11x24	86x217	106x236	-	116x245	-	116x245	-	117
11x32	86x287	106x307	-	116x316	-	116x316	-	156
11x42	86x397	107x417	-	116x425	-	116x425	-	222
17x17	152x152	170x170	170x170	177x177	177x177	177x177	177x177	144
17x30	152x275	170x301	170x301	177x301	177x301	177x301	177x301	300
17x37	141x351	170x370	170x370	177x377	177x377	177x377	177x377	384
17x49	141x456	170x481	170x481	177x483	177x483	177x483	177x483	516
22x22	200x200	220x220	220x220	220x220	220x220	220x220	220x220	289
22x30	200x275	220x300	220x300	-	-	-	-	425
22x37	200x351	220x370	220x370	-	-	-	-	544
22x45	200x426	220x450	220x450	-	-	-	-	680



biały/ white/ weiß/ белая/bílá/ blanche/ Λευκή/ bianco/ blanca



kremowy/ cream/ cremefarbig/бежевая/ krémová/ crème/ крем / crema



grafitowy/ graphite/ graphit/графитовая/ grafitová/ graphite/Граφίτη/ graphite/ grafito



granito/ серая/ granito negro



czarny/ black/ schwarz/ чёрная/ černá/ noire/Μαύρη/ nero/ negra



czarno-srebrny/ silvery blac/ schwarz-silber/ чёрная-хром/ černo-stříbrná / noire-argentée/ Μαύρο-Ασημί/ nera-argento/ negro y plata



czarno-złoty/ golden black/ schwarz-gold/ чёрная-латунь/ černo-zlatá/ noire-dorée/ Μαύρο-Χρυσό/ nera-oro/ negro y oro



miedziany/ brass/ kupferfarbig/ медная/ měděná/ cuivre/ Χαλκός/ cobre



szlifowana/ inox/ geschliffen/ стальная/ nerezová / inoxidable



niklowana/ nickel-plated/ vernickelt/ никелированная/ niklovaná/ nickelage brillant/ Νικελ/ nichelato/ lateada



pozlacana/ gold/ vergoldet/ полированная латунь/ pozlacená/ dorée/ χρυσό/ di oro/ dorada



miedź galvaniczna/ galvanized/ kupferfarbig galvanisiert/ гальванизированная медь/ galvanická měď/ galvanisée cuivrée/ χαλκός γαλβανιζέ/ rame di galvanizzare/ latón galvanizado



złoto galvaniczne/ galvanized gold/ gold galvanisiert/ гальванизированная латунь/ galvanické zlato/ galvanisée dorée/ χρυσό γαλβανιζέ/ oro di galvanizzare/ oro galvanizado



retro biały antyk/ retro white antiquity / retro antik-weiß/ ретро белая/ retro bílá antika/ retro blanche-antique/ ретро Λευκή Αντικέ/ bianco antiqua retrò/ retro-antigua blanca



retro grafitowy antyk/ retro graphite antiquity/ retro antik-graphit/ ретро графит/ retro grafit antika/ retro graphite-antique/ ретро Граφίτη Αντικέ/ graphite antiqua retrò / retro-antigua grafito

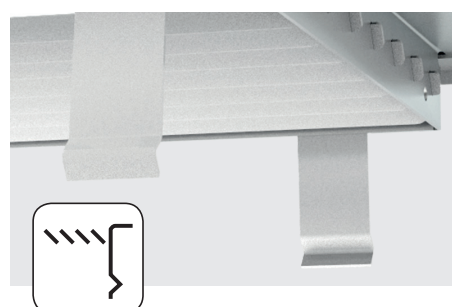
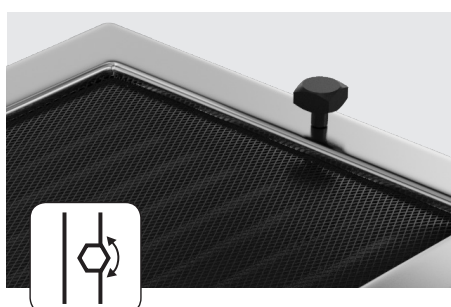
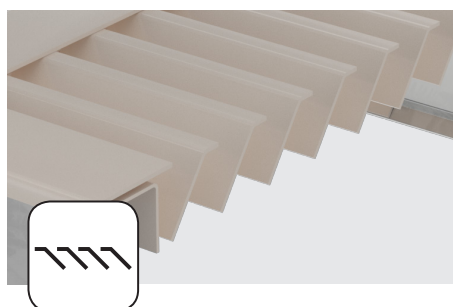



Funkcje sterownika: / Functions of the controller / Funktionen der Steuerung / Функции контроллера: / Vlastnosti Regulace / Fonctions de la régulation / Λειτουργίες / Functions of the controller: / Funciones del controlador: MSK/P100, MSK/P125, MSK/P150

- sterowanie dwoma pompami c.o. oraz jednym niezależnie nastawianym urządzeniem np. turbiną lub oświetleniem / Two CO pumps and one independently adjustable device control such as turbine or lighting / Steuerung mit zwei Umlaupumpen CO und einen unabhängigen Gerät wie z.B. Turbine oder Beleuchtung / управление двумя насосами центр. отопл. и одним независимо управляемым устройством напр. турбиной или освещением / řízení dvou čerpadel ústředního topení a jednoho nezávisle nastavitelného zařízení / contrôle de deux pompes CO et un dispositif ajustable de manière indépendante comme une turbine ou de l'éclairage / Έλεγχος 2 κυκλοφορητών και μίας ανεξάρτητα ρυθμιζόμενης συσκευής, π.χ. βεντιλατέρ ή φωτισμού / controllo a due pompe C.O. e un dispositivo regolabile autonomamente / dos bombas de CO, una de ellas independiente con control de turbina e iluminación
- sterowanie turbiną kominkową / Fireplace turbine control / Steuerung der Kaminturbine/ управление каминной турбиной / řízení ventilátoru krbové turbíny v provedení Air / Controleur pour turbine / Έλεγχος του μοτέρ διανομής θερμού αέρα / camino di controllo della turbina / control de la turbina del hogar
- precyzyjne dawkowanie powietrza do spalania / Precise dosage of air for combustion / Genau Dosierung der Luft zum Brennkammer / Высокоточное дозирование воздуха для горения / precizní dávkování vzduchu pro spalování takovým způsobem, aby bylo maximálně efektivní / Dosage précis de l'air de comburant / Ελεγχόμενη τροφοδοσία εστίας με οξυγόνο / dosaggio preciso dell'aria di combustione / dosificación precisa del aire de combustión
- zabezpieczenie przed przegrzaniem / protection against overheating / Überhitzungsschutz / Защита от перегрева / ochrana proti přehřátí / Dans le cas de la chute de la température mesurée au-dessous de 4°C , il protège l'installation contre le gel en activant la pompe CO automatiquement / Προστασία από υπερθέρμανση / Protegge automaticamente l'impianto dal gelo attivando le pompe a 4°C / protección contra sobrecalentamiento
- odcięcie dopływu powietrza w przypadku zaniku zasilania / cutting off the air supply in case of the power failure / Luftabtrennung bei Stromausfall / Прекращение подачи воздуха в случае отсутствия электричества / uzavření přívodu vzduchu v případě výpadku napájení elektrickým proudem / Ferme l'alimentation d'air comburant dans le cas d'une panne de courant / Κλείσιμο οξυγόνου σε περίπτωση διακοπής ρεύματος / interrompere l'alimentazione di aria in caso di mancanza di alimentazione / corte del suministro de aire en caso de fallo energético
- akustyczne ostrzeżenia / acoustic warning / Akustischmelder nach Alarmwiterung / Акустическое предупреждение о превышении максимально допустимой температуры нагрева / akustické varování / Alarme d'avertissement sonore en cas dépassement de la température / ακουστική προειδοποίηση σε περίπτωση θερμοκρασίας υψηλότερης, από την παράμετρο ορισμένο στον συναγερμό / Allarme acustico di alta temperatura / aviso acústico



Funkcje sterownika: / Functions of the controller / Funktionen der Steuerung / Функции контроллера: / Vlastnosti Regulace / Fonctions de la régulation / Λειτουργίες / Functions of the controller: / Funciones del controlador: MSK/PLUS/P125, MSK/PLUS/P125, MSK/PLUS/P150

- niezależne sterowanie czterema urządzeniami, np: pompami c.o., wentylatorami lub elektrozaworami / independent control of four devices, eg. pumps c.o., fans or solenoid / Unabhängige Steuerung mit vier Gerät z.B. Umlaufpumpe CO, Ventilator oder Elektroventil / Независимое управление четырьмя устройствами, напр.: насосами цент. отопл. или электроклапанами / ezavislé řízení čtyř zařízení, např.: čerpadla ústředního topení, ventilátory ke spalování / contrôle indépendant jusqu'à quatre appareils, par exemple : pompe, ventilateur, solénoïde, vanne / Ανεξάρτητος έλεγχος 4 συσκευών, π.χ. κυκλοφορητή καυστήρα, βεντιλατέρ, ηλεκτροβάνες / controllo indipendente di quattro dispositivi, ad esempio pompe che, di ventilatori o elettrovalvola / control independiente de cuatro dispositivos, por ejemplo, bombas CO, ventiladores o solenoide
- precyzyjne dawkowanie powietrza do spalania / Precise dosage of air for combustion / Genau Dosierung der Luft zum Brennkammer / Высокоточное дозирование воздуха для горения / precizní dávkování vzduchu pro spalování takovým způsobem, aby bylo maximálně efektivní / Dosage précis de l'air de comburant / Ελεγχόμενη τροφοδοσία εστίας με οξυγόνο / dosaggio preciso dell'aria di combustione / dosificación precisa del aire de combustión
- zabezpieczenie przed przegrzaniem / protection against overheating / Überhitzungsschutz / Защита от перегрева / ochrana proti přehřátí / Dans le cas de la chute de la température mesurée au-dessous de 4°C , il protège l'installation contre le gel en activant la pompe CO automatiquement / Προστασία από υπερθέρμανση / Protegge automaticamente l'impianto dal gelo attivando le pompe a 4°C / dosificación precisa del aire de combustión
- odcięcie dopływu powietrza w przypadku zaniku zasilania / cutting off the air supply in case of a power failure / Luftabtrennung bei Stromausfall / Прекращение подачи воздуха в случае отсутствия электричества / uzavření přívodu vzduchu v případě výpadku napájení elektrickým proudem / Ferme l'alimentation d'air comburant dans le cas d'une panne de courant / Κλείσιμο οξυγόνου σε περίπτωση διακοπής ρεύματος / interrompere l'alimentazione di aria in caso di mancanza di alimentazione / corte del suministro del aire en caso de fallo de suministro eléctrico
- akustyczne ostrzeżenie o przekroczeniu temperatury alarmowej / Sound warning about the exceed of the alarm temperature / Akustischmelder nach Alarmwiterung / Акустическое предупреждение / akustické varování / Alarme d'avertissement sonore en cas dépassement de la température / ακουστική προειδοποίηση σε περίπτωση θερμοκρασίας υψηλότερης, από την παράμετρο ορισμένο στον συναγερμό / Allarme acustico di alta temperatura / alarma sonora en caso de exceso de temperatura
- funkcia zapobiegania zamarznięciu wody obiegowej / antifreeze function of circulating water / Funktion der Vorbeugung der Erfrierung des Umlaufwassers / Функция предотвращения заморзания воды в контуре / funkce předcházení zamrznutí oběhové vody / fonction antigel de l'eau de circulation / Λειτουργία προστασίας από το πάγωμα νερού στο κύκλωμα / funzione per evitare il congelamento dell'acqua nell'impianto / función antihielo del agua circulante
- funkcja rozbiegu posezonowego pomp obiegowych, gdy nie są używane poza sezonem / funktion of postse

ason run of circulation pumps when they are not used out of season / Ablauffunktion der Umlaufpumpen wenn nicht benutzt sind / Функция сезонного разгона насосов, после простоя вне сезона / funkce mimosezonního rozběhu črpadel, v době kdy nejsou pravidelně v provozu / Fonction anti-blocage (mise en route automatique occasionnelle des pompes de circulation en dehors de la saison de chauffe / λειτουργία προθέρμανσης κυκλοφορητών έλπειτα από ένα διάστημα χωρίς την χρήση του τζακιού / Funzione controllo pompe fuori stagione di utilizzo / función de paro de funcionamiento fuera de temporada



Funkcje sterownika/ Functions of the controller / Funktionen der Steuerung / Функции контроллера: / Vlastnosti Regulace / Fonctions de la régulation / λειτουργίες / Functions of the controller: / Funciones del controlador: MSK

- sterowanie dwoma wyjściami, do których standardowo podłączane są maksymalnie 2 pompy obiegowe c.o. (1 wyjście) i np. zawór (2 wyjście) / The control of two exits which, in standard, have got a connection with maximum 2 circulation CO pumps (1st exit) and e.g. valve (2nd exit) / Steuerung mit zwei Ausgänge an welche sind im Standard zwei Umlaufpumpen CO angeschlossen (1 Ausgang) und z.B. Ventil (2 Ausgang) / Контроль двух выходов, к которым обычно присоединены максимально 2 циркуляционных насоса ЦО (1 выход), и например клапан (2 выход) / ovládání dvou výstupů, které ve standardu mají propojení s max. dvěma čerpadly / Contrôle indépendant jusqu'à deux appareils, en général une pompe et par exemple: ventilateur, solénoïde, vanne / έλεγχος δυο εξόδων – κυκλοφορητή (1 έξοδος) και π.χ. βαλβίδα (2 έξοδος) / controllo di due uscite, che tipicamente sono collegate ad un massimo di due pompe di circolazione a (1 out), e tale valvola (2 ye) / el control de 2 salidas estándar dispone de un máximo de 2 bombas de circulación
- akustyczne ostrzeżenie o przekroczeniu temperatury alarmowej / Sound warning about the exceed of the alarm temperature / Akustischmelder nach Alarmwiterung / Акустическое предупреждение о превышении максимально допустимой температуры нагрева / akustické varování / Alarme d'avertissement sonore en cas de dépassement de la température / ακουστική προειδοποίηση σε περίπτωση θερμοκρασίας υψηλότερης, από την παράμετρο ορισμένο στον συναγερμό / Allarme acustico di alta temperatura / alarma sonora en caso de exceso de temperatura
- zabezpiecza instalację przed zamrażaniem automatycznie włączając pompę c.o. przypadku spadku mierzonej temperatury poniżej 4°C / In case of the drop of the measured temp. below 4°C it protects the installation from freezing by turning on the CO pump automatically / Automatische Anschaltung der Umlaufpumpe CO, wenn die Temperatur unten 4 Grad fählt / Защищает систему от замерзания автоматически включая насос ЦО в случае падения температуры ниже 4°C / protizámrazová funkce rozběhem črpadel pod 4°C / Dans le cas de la chute de la température mesurée au-dessous de 4°C, il protège l'installation contre le gel en activant la pompe CO automatiquement / προστατεύει το κύκλωμα από πάγωμα με αυτόματη ενεργοποίηση του κυκλοφορητή, σε περίπτωση εξωτερικής θερμοκρασίας κάτω των 4°C / Protegge automaticamente l'impianto dal gelo attivando le pompe a 4°C / en caso de que la temperatura baje por debajo de 4°C, existe una protección automática anti-hielo
- samoczynne wyjście ze stanu uśpienia przy wykryciu wzrostu temperatury cieczy w instalacji / Automatic exit from the sleep state in case of detecting the rise of the temperature of the liquid in the installation / Automatische Ausgang von Stillstand bei Erhöhung der Flüssigkeit in der Installation / Автоматический выход из состояния сна при повышении температуры жидкости в системе / automatický přechod z režimu spánku v případě detekování nárůstu teploty topné vody / Sortie automatique de l'état de veille en cas de détection de la montée en température du liquide de circulation dans l'installation / αυτόματη ενεργοποίηση μετά τον εντοπισμό αυξημένης θερμοκρασίας υγρού στο κύκλωμα / uscita automatica dallo stato di riposo dell'aumento di temperatura del liquido viene rilevato nel sistema / salida automática de posición 2 sleep, en caso de detectar una bajada de la temperatura del líquido en la instalación



Funkcje sterownika: / Functions of the controller / Funktionen der Steuerung / Функции контроллера: / Vlastnosti Regulace / Fonctions de la régulation / λειτουργίες / Functions of the controller: / Funciones del controlador MSK/GLASS/P125, MSK/GLASS/P125, MSK/GLASS/P150

- sterowanie dwoma pompami c.o. oraz jednym niezależnie nastawianym urządzeniem np. turbiną lub oświetleniem / Two CO pumps and one independently adjustable device control such as turbine or lightening / Steuerung mit zwei Umlaufpumpen CO und einen unabhängigen Gerät wie z.B. Turbine oder Beleuchtung / управление двумя насосами центр. отопл. и одним независимо управляемым устройством напр. турбиной или освещением / řízení dvou črpadel ústředního topení a jednoho nezávisle nastavitelného zařízení / contrôle de deux pompes CO et un dispositif ajustable de manière indépendante comme une turbine ou de l'éclairage / Έλεγχος 2 κυκλοφορητών και μίας ανεξάρτητα ρυθμιζόμενης συσκευής, π.χ. βεντιλατέρ ή φωτισμού / controllo a due pompe C.O. e un dispositivo regolabile autonomamente / dos bombas de CO, una de ellas independiente con control de turbina e iluminación
- sterowanie turbiną kominkową / controlling the chimney turbine in the Air option / Steuerung der Kaminturbine / управление каминной турбиной / řízení ventilátoru krbové turbíny v provedení Air / Controleur pour turbine / Έλεγχος του μοτέρ διανομής θερμού αέρα / camino di controllo della turbina / control de la turbina de la chimenea en opción aire
- precyzyjne dawkowanie powietrza do spalania / Precise dosage of air for combustion / Genau Dosierung der Luft zum Brennkammer / Высокоточное дозирование воздуха для горения / precizní dávkování vzduchu pro spalování takovým způsobem, aby bylo maximálně efektivní / Dosage précis de l'air de comburant / Ελεγχόμενη τροφοδοσία εστίας με οξυγόνο / dosaggio preciso dell'aria di combustione / dosificación precisa del aire de combustión
- zabezpieczenie przed przegrzaniem / protection against overheating / Überhitzungsschutz / Защита от перегрева / ochrana proti přehřátí / Dans le cas de la chute de la température mesurée au-dessous de 4°C, il protège l'installation contre le gel en activant la pompe CO automatiquement / Προστασία από υπερθέρμανση / Protegge automaticamente l'impianto dal gelo attivando le pompe a 4°C / protección contra sobrecalentamiento
- odcięcie dopływu powietrza w przypadku zaniku zasilania / cutting off the air supply in case of the power failure / Luftabtrennung bei Stromausfall / Прекращения подачи воздуха в случае отсутствия электричества / uzavření přívodu vzduchu v případě výpadku napájení elektrickým proudem / Ferme l'alimentation d'air comburant dans le cas d'une panne de courant / Κλείσιμο οξυγόνου σε περίπτωση διακοπής ρεύματος / interrompere l'alimentazione di aria in caso di mancanza di alimentazione / corte de suministro del aire en caso de fallo de suministro eléctrico

- akustyczne ostrzeżenia / acoustic warning / Akustischmelder nach Alarmweiterung / Акустическое предупреждение о превышении максимально допустимой температуры нагрева / akustické varování / Alarme d'avertissement sonore en cas de dépassement de la température / ακουστική προειδοποίηση σε περίπτωση θερμοκρασίας υψηλότερης από την παράμετρο ορισμένο στον συναγερμό / Allarme acustico di alta temperatura / aviso acústico



Funkcje sterownika: / Functions of the controller / Funktionen der Steuerung / Функции контроллера: / Vlastnosti Regulace / Fonctions de la régulation / Λειτουργίες / Functions of the controller: EKO/LINE/W, EKO/LINE/B

- obsługa wkładów z płaszczem wodnym i z dystrybucją gorącego powietrza / The service of the fireplaces with water jacket and with hot air distribution system / Bedienung der wasserführenden Kamineinsätzen und Warmluftofen / обслуживание каминов с водным контуром и с разводкой горячего воздуха / obsluha teplovodních vložek a systémů distribuce horkého vzduchu / Utilisation pour un foyer hydraulique et/ou un système de distribution d'air chaud / Τοποθέτηση σε εστίες καλοριφέρ και αέρος / Controlli per il servizio alla camicia d'acqua e la distribuzione di aria calda / Servicio para los hogares con paila y con distribuidor de aire caliente

- 4 czujniki temperatury PT100 / 4 temperature sensors PT100 / 4 x Tempertarmessgerät PT100 / 4 датчика температуры ПТ100 / 4 teplotní senzory PT100 / 4 Senseurs de temperature PT100 / 4 αισθητήρες θερμοκρασίας PT100 / 4 sensori di temperature / 4 aparatos de medición de temperatura PT100

- sterowanie 4 pompami (CO/CWU) / 4 pumps (CO/CWU) control / Steuerung der 4 Pumpen (CO/CWO) / Управление 4 насосами / regulace 4 čerpadel / 4 controlleurs de pompe (CO/CWU) / Έλεγχος μέχρι 4 ανεξάρτητων κυκλοφορητών / controllo di 4 pompe (CO/ACS) / 4 bombas de control (CO/CWU)

- sterowanie grzałką ogrzewania CWU / CWU heater control / Steuerung des Heizelementes der Heizung CWO / управление горелкой нагрева ЦВУ / regulace teploty v akumuláční nádobě / Gestion du controleur de temperature CWU / Έλεγχος θερμοκρασίας boiler / controllo del riscaldatore di acqua calda sanitaria / control de calefactor CWU

- sterowanie piecem CO (wyłączanie po rozpaleniu kominka) / CO furnace control (switching off after lighting the fire) / Steuerung der CO Kessel( Abschaltung nach Anzündung des Kamins / управление уровнем ЦО (исключительно после розжига камина) / ovládání kotle (vypnutí po zapálení ohně v krbu) / Controleur de fumée (CO) (se coupe automatiquement après l'allumage du feu) / Έλεγχος του καυστήρα (απενεργοποίηση του μετά από το άναμμα εστίας) / controllo del focolare CO (arresto dopo accensione dell camino) / mando de la caldera CO (paro al encendido del hogar)

- płynne sterowanie dmuchawą dystrybucji ciepłego powietrza / Smooth control of the hot air distribution turbine / Flissende Steuerung des Luftgebläses der Warmluftverteilung / Постоянное управление вентилятором дистрибуции теплого воздуха / plynulé ovládání teplovzdušného ventilátoru / Contrôle de la turbine de distribution d'air chaud / Αυτορμείωση στροφών του βεντιλατέρ / controllo regolare della velocità del ventilatore di aria calda / control suave de la turbina de aire caliente

- czujnik otwarcia drzwiczek kominka / Fireplace door opening sensor / Tür-Öffnung-Fühler / датчик открытия дверцы камина / čidlo otevření dvířek krbu / Senseur d'ouverture de porte / Αισθητήρας συναγερμού ανοιχτής πόρτας / sensore di apertura della porta focolare / sensor de apertura de la puerta del hogar

- wygaszenie paleniska po zasygnalizowaniu pożaru przez centralkę PPOŻ. / Extinguishing the hearth after the message about the fire from central panel PPOŻ / Auslöschung der Brennkammer nach Feuermelden durch Brandschutzzentrale / Прекращение горения в топке по сигналу о пожаре от панели управления ППОЖ / Vyhasnutí topeniště při signalizaci požáru na centrále PO / Mise en situation favorisant l'extinction du feu dans le foyer après avoir reçu un message «feu» du panneau central PPOŻ / Αυτόματο σβήσιμο εστίας μετά από τον συναγερμό πυρκαγιάς του αισθητήρα PPOŻ / Spegnerne il focolare alla segnalazione acustica della centralina / paro del hogar tras mensaje de fuego proporcionado por el panel PP02

## NASADY KOMINKOWE

CHIMNEY HEADS/KAMIN ABGASWÄRMETAUSCHER/ДЫМОХОДНЫЕ ТЕПЛООБМЕННИКИ / KRBOVÉ NÁSTAVCE / TÊTE D'INSERT ÉCHANGEUR AIR/EAU / ΕΝΑΛΛΑΚΤΕΣ ΚΑΠΝΑΕΡΙΩΝ / TESTE DI CAMINO / INTERCAMBIADORES DE CALOR

Zadaniem nasad jest odzyskanie ciepła ze spalin wypływających z kominka do przewodu kominkowego. Pozwalają w znacznym stopniu odebrać traczone bezpowrotnie ciepło ze spalin. Jest to bardzo ekonomiczne źródło ciepła, ponieważ nie wymaga zużycia dodatkowej ilości opału.

W nasadach wodnych ciepło oddawane jest do wody znajdującej się w nasadzie i dystrybuowane do odbiorników ciepła, np. grzejników, zasobnika ciepłej wody użytkowej. Przy montażu i użytkowaniu stosowane są te same zasady, które obowiązują przy kominkach z płaszczem wodnym.

Nasady wodne to idealna alternatywa dla osób, które zainstalowały kominek powietrzny i nie chcą go wymieniać na kominek z płaszczem, a jednocześnie widzą możliwość wykorzystania dodatkowej porcji energii.

W nasadach powietrznych dzięki specjalnemu układowi płomieniówek przekazują ciepło do obudowy, a przy wykorzystaniu systemu dystrybucji gorącego powietrza dalej do pomieszczeń mieszkalnych.

The purpose of use the chimney heads is to recover heat from the exhaust gases flowing from the chimney into the fireplace.

They allow you to pick up significantly irretrievably lost heat from the flue gases. It is a very economical source of heat, it does not require an additional amount of fuel consumption.

In water chimney heads the heat is transferred to water in the chimney head and distributed to the receivers of heat, such as radiators or hot water tank. The assembly and use are the same like with the fireplaces with water jacket. It is an ideal alternative for people, which installed an air fireplace and do not want to exchange it for the fireplace with water jacket, and at the same time hope to use reserved energy.

With the air chimney heads thanks to a special pipe system heat is transferred to the casing, and using hot air distribution system it is transferred to the other rooms.



Die Abgaswärmetauscher ist ein Kaminaufsatz, der auf dem Rauchrohr des Kamineinsatzes installiert wird.

Seine Aufgabe ist es die Restwärme dem Rauch zu entziehen und an das Wasser oder Luft (je nach Modell) weiterzuleiten.

Es ist eine sehr ökonomische Quelle von Wärme, ist es nicht erforderlich eine zusätzliche Menge des Kraftstoffverbrauchs.

Bei Montage der Abgaswärmetauscher gelten dieselben Regelungen und Prinzipien wie bei wasserführenden Kamineinsatzes.

Warmwasser-Abgaswärmetauscher ist eine perfekte Alternative für Menschen, die einen Warmluftkamin installiert und wollen nicht, um es für einen Wassermantelkamin auszutauschen.

Im Luft-Abgaswärmetauscher dank die Heizrohre die Wärme ist an die Kaminbausatz weitergeleitet und dann durch Wärmeverteilungssystem wieder an die Wohnung.

Дымоходные теплообменники предназначены для дополнительной отдачи тепла от продуктов сгорания, отводящихся в дымоход.

Они позволяют в значительной степени отобрать уходящее тепло от продуктов сгорания. Это очень экономичный источник тепла, который не требует использования дополнительного количества топлива.

В водных дымоходных теплообменниках тепло передается в воду, которая находится в теплообменнике и дальше транспортируется по системе в радиаторы или бак для горячей бытовой воды.

При монтаже и эксплуатации применяются те же правила, которые используются в отношении каминов с водным контуром.

Водные дымоходные теплообменники - это идеальная альтернатива для тех, кто уже установил каминную топку под воздушное отопление и не желает менять её на камин с водным контуром, и в то же время видят возможность использования дополнительного количества энергии. В воздушных дымоходных теплообменниках благодаря специальному размещению трубок тепло передаётся в горячую камеру, а при использовании систем разводки горячего воздуха – дальше к жилым помещениям.

Úkolem nástavců je získávání tepla ze spalin, které vycházejí z krbu do kouřovodu. Výrazným způsobem umožňují odebrat nenávratně unikající teplotu ze spalin. Jedná se o velmi ekonomický zdroj tepla, protože nevyžaduje žádné další palivo.

Ve vodních nástavcích je teplota předávána do vody, která se nachází v nástavci a je distribuována do topných těles zásobníku na teplou užitkovou vodu. Pro montáž a použití platí stejné zásady, jaké se vztahují na krby s vodními pláštěmi.

Vodní nástavce jsou ideální alternativou pro osoby, které si nainstalovaly klasický krb a nechtějí jej měnit za krb s vodním pláštěm, ale současně vidí možnost využití dodatečné porce energie.

Ve vzduchových nástavcích se díky speciálnímu systému žebírek předává teplo do pláště a prostřednictvím systému rozvodu horkého vzduchu je rozváděno dále do místností

L'installation d'un échangeur Air/Eau sur un insert à bois permet de récupérer la chaleur des fumées de combustion perdus, et ainsi transférer cette source de chaleur vers une installation de chauffage existante.

C'est une source d'énergie très économique permet d'optimiser le rendement de votre insert, par la récupération de la chaleur sans augmenter la consommation bois. En passant dans l'échangeur, la chaleur des fumées de combustion est transférée au circuit d'eau par contact avec le système spécifique de tuyaux et de la chemise d'eau de l'échangeur.

Ainsi, l'on peut distribuer cette chaleur à une installation avec des radiateurs à eau ou un ballon à accumulation d'eau par exemple (généralement installé en „relevage“ du système de chauffage principal). Cette solution est l'alternative idéale pour les installations existantes, ce qui permet de bénéficier du confort d'un insert bouilleur sans avoir à changer l'insert existant.

Ο βασικός σκοπός λειτουργίας των εναλλακτών είναι εκμετάλλευση θερμότητας από τα καπναέρια στην είσοδό τους από την εστία στην καμινάδα.

Επιτρέπουν την απαγωγή ζέστης, η οποία συνήθως χάνεται στην καμινάδα και την ατμόσφαιρα.

Είναι μια πολύ οικονομική πηγή θέρμανσης, διότι δεν απαιτεί επιπλέον καύσιμο.

Στους εναλλάκτες νερού η ζέστη μεταφέρεται στους τουμπροσωλήνες, οι οποίοι περιέχουν νερό και στην συνέχεια διανέμεται στο κύκλωμα, πχ. στα καλοριφέρ, μπόιλερ κλπ.

Η τοποθέτηση και η χρήση ακολουθεί σύμφωνα με τους ίδιους κανόνες, όπως με τις εστίες νερού. Οι εναλλάκτες νερού αποτελούν ιδανική λύση για τους χρήστες αερόθερμων ενεργειακών εστιών, οι οποίοι δεν επιθυμούν την αντικατάσταση εστίας με σύστημα νερού, αλλά παρόλα αυτά έχουν την δυνατότητα να εξοικονομήσουν μια μεγάλη δόση επιπλέον ενέργειας.

Στους εναλλάκτες αέρα, η ζέστη μεταφέρεται στους ειδικά τοποθετημένους σωλήνες και στη συνέχεια στον θερμοθάλαμο, από τον οποίο ακολουθεί η διανομή θερμού αέρα στους χώρους του σπιτιού.

Lo scopo di utilizzo delle teste camino è recuperare calore dai gas di scarico fluisce dal camino nel focolare.

Essi consentono di raccogliere il calore in modo significativo irrimediabilmente persi dai fumi.

Si tratta di una fonte di calore molto economico, non richiede una quantità aggiuntiva di consumo di carburante.

In testa camini acqua il calore viene ceduto all'acqua in testa canna fumaria e distribuito ai ricevitori di calore, quali radiatori o serbatoio di acqua calda. Il montaggio e l'uso sono gli stessi come con i camini con camicia d'acqua.

Si tratta di una alternativa ideale per le persone, che hanno installato un camino d'aria e non vogliono scambiarlo per il camino con camicia d'acqua, e allo stesso tempo vogliono di utilizzare l'energia riservata.

Le teste dei camini d'aria hanno un sistema di tubi grazie a quali il calore speciale viene trasferito alla carcassa e con il sistema di distribuzione dell'aria calda è trasferita alle altre camere.

El intercambiador de calor para salida de gases es un inserto para colocar a la salida de humos.

Su misión es recuperar el calor residual y transmitirlo al aire o al agua en función de cada modelo. Es una fuente de calor muy económica, no es necesario incrementar el consumo de combustible.

Al montar este elemento deben seguirse las mismas reglas y principios como los hogares para calentar agua. El intercambiador de calor para gases residuales para agua es una alternativa perfecta para aquellos que instalan una chimenea calefactora a aire y no quieren hacer un gasto adicional para un intercambiador de agua. En este intercambiador, gracias a su sistema de tubos, se recupera gran cantidad de calor que es restituido a la vivienda.

## Turbodým powietrzny $\varnothing 200$

Air turbo-smoke  $\varnothing 200$  / Turborach Luft  $\varnothing 200$  / Турбодым воздушный  $\varnothing 200$  / Teplovzdušný výměník  $\varnothing 200$  / Récupérateur de chaleur de la fumée à air  $\varnothing 200$  / Εναλλάκτης αέρος  $\varnothing 200$  / Estrattore d'aria  $\varnothing 200$  / Air-turbo  $\varnothing 200$

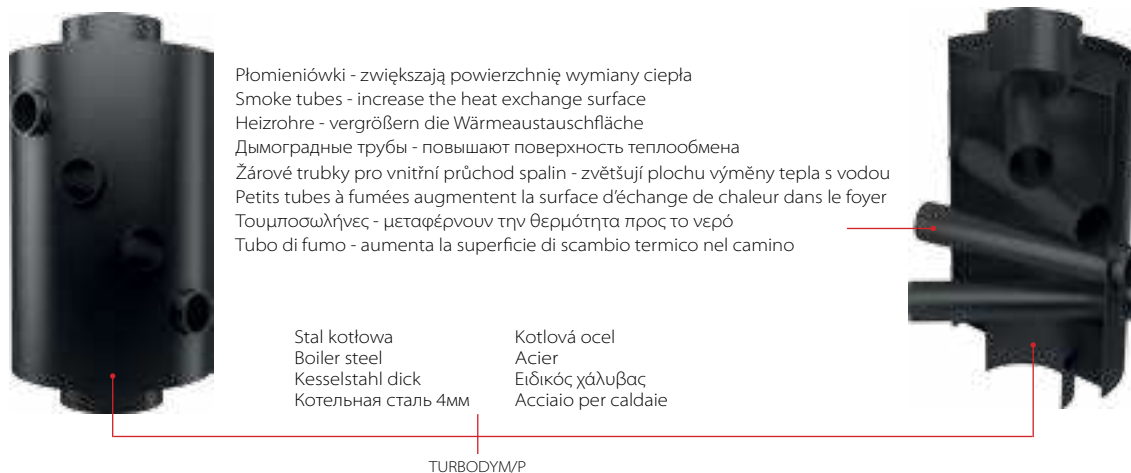

Plomieniówki - zwiększają powierzchnię wymiany ciepła  
Smoke tubes - increase the heat exchange surface  
Heizrohre - vergrößern die Wärmeaustauschfläche  
Дымоградные трубы - повышают поверхность теплообмена  
Žárové trubky pro vnitřní průchod spalin - zvětšují plochu výměny tepla s vodou  
Petits tubes à fumées augmentent la surface d'échange de chaleur dans le foyer  
Τουμποσωλήνες - μεταφέρουν την θερμότητα προς το νερό  
Tubo di fumo - aumenta la superficie di scambio termico nel camino

Stal kotłowa  
Boiler steel  
Kesselstahl dick  
Котельная сталь 4мм

Kotłová ocel  
Acier  
Ειδικός χάλυβας  
Acciaio per caldaie

TURBODYM/P

## Krażki akumulacyjne $\varnothing 200$ , zestaw 4 krażki, zestaw 5 krażków, krażek 1 sztuka

Set of 4 psc of cast iron accumulation discs with brackets, Set of 5 psc, Set of 1 psc / Wärmeakkumulationsscheibe  $\varnothing 200$ , im Set 4 Scheiben, im Set 5 Scheiben, 1 Stück/Акумуляционные кольца  $\varnothing 200$ , комплект 4 кольца, комплект 5 колец, 1 кольцо / Akumulační disky  $\varnothing 200$ , 4 disky s držáky, 5 disky s držáky, itinový akumulační disk / Disques d'accumulation de chaleur  $\varnothing 200$ , complet 4 disques, complet 5 disques, disque 1 pc. / Δακτυλιδια συσώρευσης  $\varnothing 200$ , σετ των 4 δακτυλιδιών, σετ των 5 δακτυλιδιών, δακτυλιό 1 τεμάχιο / I dischi di accumulo di ghisa  $\varnothing 200$ , set di 4 pezzi, set di 5 pezzi, 1 pezzo



Želiwo szare klasy 200  
Grey cast iron class 200  
Graues Gusseisen Klasse 200  
Чугунн класс 200  
Šedá litina třídy 200  
Fonte grise classe 200  
Μαντέμι ποιότητας 200  
Ghisa, Classe 200  
Fundición gris clase 200

KRAZEK/A/Z4

KRAZEK/A/Z5

KRAZEK/A

## Turbodým wodny $\varnothing 200$

Water turbosmoke  $\varnothing 200$  / Turborach wasserführend  $\varnothing 200$  / Турбодым водный  $\varnothing 200$  / Teplovodní výměník  $\varnothing 200$  / Récupérateur de chaleur de la fumée à eau  $\varnothing 200$  / Εναλλάκτης νερού  $\varnothing 200$  / Estrattore d'acqua  $\varnothing 200$  / Water-turbo  $\varnothing 200$

## Turbodým wodny z węzownicą $\varnothing 200$

Water turbosmoke with coil pipe  $\varnothing 200$  / Turborach wasserführend mit dem Siecherheitswärmetauscher  $\varnothing 200$  / Турбодым водный со змеевиком  $\varnothing 200$  / Teplovodní výměník se smyčkou  $\varnothing 200$  / Récupérateur de chaleur de la fumée à eau avec serpentin de chauffage  $\varnothing 200$  / Εναλλάκτης νερού με σπράλ ψύξης  $\varnothing 200$  / Estrattore d'acqua con serpentina  $\varnothing 200$  / Intercambiador de calor de seguridad de  $\varnothing 200$

Plomieniówki - zwiększają powierzchnię wymiany ciepła  
Smoke tubes - increase the heat exchange surface  
Heizrohre - vergrößern die Wärmeaustauschfläche  
Дымоградные трубы - повышают поверхность теплообмена

Žárové trubky pro vnitřní průchod spalin - zvětšují plochu výměny tepla s vodou  
Petits tubes à fumées augmentent la surface d'échange de chaleur dans le foyer  
Τουμποσωλήνες - μεταφέρουν την θερμότητα προς το νερό  
Tubo di fumo - aumenta la superficie di scambio termico nel camino  
Incremento de la superficie de intercambio de calor



Węzownica  
Coil pipe  
Sicherheitswärmetauscher  
Змеевик  
Chladící smyčka  
Serpentin pour foyer chaudière  
Σπράλ ασφαλείας  
Serpentina  
Intercambiador de calor

Stal kotłowa  
Boiler steel  
Kesselstahl dick  
Котельная сталь 4мм  
Kotłová ocel  
Acier  
Ειδικός χάλυβας  
Acciaio per caldaie  
acero refractario de 4mm

TURBODYM/W

TURBODYM/W/W

## Turbodým wodny nagrzewnica pionowa $\varnothing 200$

Water turbosmoke with vertical smoke tubes  $\varnothing 200$  / Turбораuch wasserföhrend mit vertikalen Heizrohren  $\varnothing 200$  / Турбодým водный с вертикальным нагревателем  $\varnothing 200$  / Teplovodní výměník s vertikálními trubicemi  $\varnothing 200$  / Récupérateur de chaleur de la fumée à eau avec tubes à fumée verticaux  $\varnothing 200$  / Εναλλάκτης νερού με κάθετο τουμποσωλήνα  $\varnothing 200$  / Estrattore d'acqua con riscaldatore verticale  $\varnothing 200$

Plomieniówki - zwiększają powierzchnię wymiany ciepła  
Smoke tubes - increase the heat exchange surface  
Heizrohre - vergrößern die Wärmeaustauschfläche  
Дымоградные трубы - повышают поверхность теплообмена



Stal kotłowa  
Boiler steel  
Kesselstahl dick  
Котельная сталь 4мм  
Kotlová ocel  
Acier  
Ειδικός χάλυβας  
Acciaio per caldaie  
acero refractario de 4mm

TURBODYM/NP

## Turbodým wodny nagrzewnica pionowa z wężownicą $\varnothing 200$

Water turbosmoke with vertical smoke tubes with coil pipe  $\varnothing 200$  / Turбораuch wasserföhrend mit vertikalen Heizrohren und mit Sicherheitswärmetauscher  $\varnothing 200$  / Турбодým водный с вертикальным нагревателем и змеевиком  $\varnothing 200$  / Teplovodní výměník s vertikálními trubicemi se smyčkou  $\varnothing 200$  / Récupérateur de chaleur de la fumée à eau avec tubes à fumée verticaux avec serpentín de chauffage  $\varnothing 200$  / Εναλλάκτης νερού με κάθετο τουμποσωλήνα και σπύραλ  $\varnothing 200$  / Estrattore d'acqua con riscaldatore verticale con serpentina  $\varnothing 200$

Žárové trubky pro vnitřní průchod spalin - zvětšují plochu výměny tepla s vodou  
Petits tubes à fumées augmentent la surface d'échange de chaleur dans le foyer  
Τουμποσωλήνες - μεταφέρουν την θερμότητα προς το νερό  
Tubo di fumo - aumenta la superficie di scambio termico nel camino  
Incremento de la superficie de intercambio de calor



Wężownica  
Coil pipe  
Sicherheitswärmetauscher  
Змеевик  
Chladící smyčka  
Serpentin pour foyer chaudière  
Σπύραλ ασφαλείας  
Serpentina  
Intercambiador de calor

TURBODYM/NP/W

## Wymiennik ciepłej wody $\varnothing 180$ , $\varnothing 200$

Water heat exchangers  $\varnothing 180$ ,  $\varnothing 200$  / Warmwasser-Wärmetauscher  $\varnothing 180$ ,  $\varnothing 200$  / Водный теплообменник  $\varnothing 180$ ,  $\varnothing 200$  / Teplovodní výměník bez trubek  $\varnothing 180$ ,  $\varnothing 200$  / échangeur de l'eau chaude  $\varnothing 180$ ,  $\varnothing 200$  / Κωνικός εναλλάκτης νερού  $\varnothing 180$ ,  $\varnothing 200$  / Scambiatore dell'acqua calda  $\varnothing 180$ ,  $\varnothing 200$

Plomieniówki - zwiększają powierzchnię wymiany ciepła  
Smoke tubes - increase the heat exchange surface  
Heizrohre - vergrößern die Wärmeaustauschfläche  
Дымоградные трубы - повышают поверхность теплообмена



WCW2/180  
WCW2/200

Stal kotłowa  
Boiler steel  
Kesselstahl dick  
Котельная сталь 4мм  
Kotlová ocel  
Acier  
Ειδικός χάλυβας  
Acciaio per caldaie  
acero refractario de 4mm

## Wymiennik ciepłej wody z rurkami $\varnothing 180$ , $\varnothing 200$

Water heat exchangers with coil pipe  $\varnothing 180$ ,  $\varnothing 200$  / Warmwasser-Wärmetauscher mit Rohren  $\varnothing 180$ ,  $\varnothing 200$  / Водный теплообменник с трубками  $\varnothing 180$ ,  $\varnothing 200$  / Teplovodní výměník s trubkami  $\varnothing 180$ ,  $\varnothing 200$  / échangeur de l'eau chaude avec tubes  $\varnothing 180$ ,  $\varnothing 200$  / Κωνικός εναλλάκτης νερού με σύστημα σωλήνων  $\varnothing 180$ ,  $\varnothing 200$  / Scambiatore dell'acqua calda con i tubi  $\varnothing 180$ ,  $\varnothing 200$

Žárové trubky pro vnitřní průchod spalin - zvětšují plochu výměny tepla s vodou  
Petits tubes à fumées augmentent la surface d'échange de chaleur dans le foyer  
Τουμποσωλήνες - μεταφέρουν την θερμότητα προς το νερό  
Tubo di fumo - aumenta la superficie di scambio termico nel camino  
Incremento de la superficie de intercambio de calor



WCW/180  
WCW/200



# W końcu każdy lubi... posiedzieć przy kominku

After all, everybody likes... sitting at the fireplace

Schließlich mag jeder.... am Kamin sitzen

Ведь все любят... посидеть у камина

Každý má rád posezení u krbu

En fin de compte, tout le monde aime... s'asseoir près de la cheminée

Σε τελική ανάλυση... σε όλους αρέσει να κάθονται γύρω από το τζάκι

Alla fine a tutti piace sedersi accanto ad un camino

Al fin y al cabo, siempre está bien estar junto a una chimenea





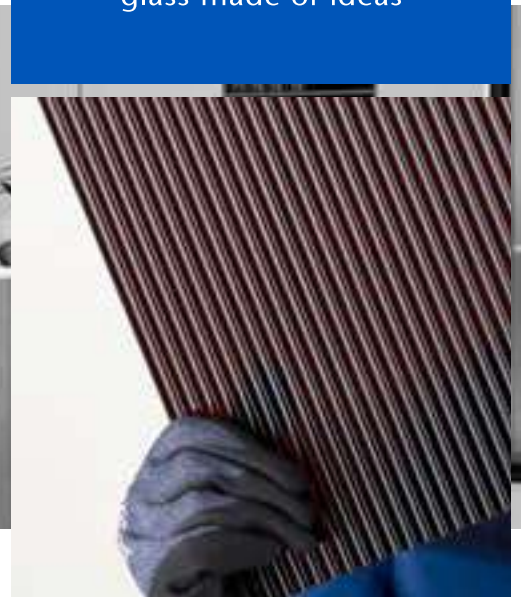

**SCHOTT is a leading international technology group in the areas of specialty glass and glass-ceramics. With more than 130 years of outstanding development, materials and technology expertise we offer a broad portfolio of high-quality products and intelligent solutions that contribute to our customers' success.**

Our true passion for glass is sparked by imagination and fueled by expertise. Whatever you envision, we will find a way to realize it.

We reinvent glass in all its numerous properties. We can bend it, roll it up and off, combine it with metal, light it up, make it round, turn it into glass powder or make it ultra-thin. SCHOTT creates solutions that bring unique products and novel applications to life – “glass made of ideas”.



**SCHOTT jest wiodącą międzynarodową grupą technologiczną w dziedzinie szkła specjalistycznego i ceramiki szklanej. Dzięki ponad 130-letniemu doświadczeniu w zakresie rozwoju, materiałów i technologii oferujemy szeroką paletę wysokiej jakości produktów i inteligentnych rozwiązań, które przyczyniają się do sukcesu naszych klientów.**

Nasza pasja do szkła jest rozbudzona przez wyobraźnię i podsycona fachową wiedzą. Cokolwiek Państwo sobie wyobrażacie, znajdziemy sposób, aby to zrealizować. Odkrywamy na nowo szkło we wszystkich jego licznych właściwościach. Możemy je zginać, zwijać, łączyć z metalem, podpalać, zaokrąglać, zamieniać w proszek szklany lub robić je ultracienkie. SCHOTT tworzy rozwiązania, które wprowadzają w życie unikalne produkty i nowe zastosowania.



**Kratki.pl Marek Bal**

ul. Gombrowicza 4, Wsola, 26-660 Jedlińsk, Polska  
tel. 00 48 48 389 99 00, [www.kratki.com](http://www.kratki.com)

[www.facebook.com/kratkipl](http://www.facebook.com/kratkipl)  
[www.youtube.com/kratkipl](http://www.youtube.com/kratkipl)  
[www.instagram.com/kratki.pl](http://www.instagram.com/kratki.pl)



16/10/2020